

LENNOX[®]

HEARTH PRODUCTS

INSTALLATION INSTRUCTIONS

SERENE HEAT SERIES

18" & 24" Dual-Listed Gas Log Sets
P/N 850,012M REV. A 03/2002

MODELS

<i>PVFGL-18VN</i>	<i>PVFGL-24VN</i>
<i>PVFGL-18VP</i>	<i>PVFGL-24VP</i>
<i>PVFGL-18MN</i>	<i>PVFGL-24MN</i>
<i>PVFGL-18MP</i>	<i>PVFGL-24MP</i>

RETAIN THESE INSTRUCTIONS FOR FUTURE REFERENCE

Warnock Hersey



WARNING: IF THE INFORMATION IN THIS MANUAL IS NOT FOLLOWED EXACTLY, A FIRE OR EXPLOSION MAY RESULT CAUSING PROPERTY DAMAGE, PERSONAL INJURY OR LOSS OF LIFE.

FOR YOUR SAFETY: Do not store or use gasoline or other flammable vapors or liquids in the vicinity of this or any other appliance.

FOR YOUR SAFETY: What to do if you smell gas:

- **DO NOT** light any appliance.
- **DO NOT** touch any electrical switches.
- **DO NOT** use any phone in your building.
- Immediately call your gas supplier from a neighbor's phone.

Follow your gas suppliers instructions.

- If your gas supplier cannot be reached, call the fire department.

Installation and service must be performed by a qualified installer, service agency or the gas supplier.

WARNING: IMPROPER INSTALLATION, ADJUSTMENT, ALTERATION, SERVICE OR MAINTENANCE CAN CAUSE INJURY OR PROPERTY DAMAGE. REFER TO THIS MANUAL. FOR ASSISTANCE OR ADDITIONAL INFORMATION CONSULT A QUALIFIED INSTALLER, SERVICE AGENCY OR THE GAS SUPPLIER.

WARNING: DO NOT BUILD A WOOD FIRE. DO NOT BURN WOOD OR OTHER MATERIAL IN THESE APPLIANCES.

CAREFULLY REVIEW THE INSTRUCTIONS SUPPLIED WITH THE DECORATIVE TYPE UNVENTED ROOM HEATER FOR THE MINIMUM FIREPLACE SIZE REQUIREMENT.

DO NOT INSTALL THE APPLIANCE IN THIS FIREBOX, UNLESS THIS FIREBOX MEETS THE MINIMUM DIMENSIONS REQUIRED FOR THE INSTALLATIONS.

This is an unvented gas log appliance. It uses air (oxygen) from the room in which it is installed. Provisions for adequate combustion and ventilation air must be provided. Refer to Combustion and Ventilation Air Section, Page 3.

Due to high temperatures, the appliance should be located out of traffic and away from furniture or draperies.

Do not place clothing or other materials on or near this appliance.

IMPORTANT: READ AND UNDERSTAND THESE INSTRUCTIONS COMPLETELY BEFORE INSTALLING YOUR UNVENTED ROOM HEATERS.

TABLE OF CONTENTS

General Information	page	2
Inventory	page	2
Tools Required	page	2
Important Safety Information	page	2
Codes	page	3
Combustion and Ventilation Air	page	3
Preinstallation	page	4
Clearances	page	4
Installation	page	6
Gas Pressure Check	page	6
Flame Appearance	page	7
Operation	page	8
Cleaning and Servicing	page	8
Replacement Parts	page	8
Accessories	page	8
Millivolt Wiring Diagram	page	10
Appliance Specification Chart	page	10
Manual Wiring Diagram	page	11
Appliance Specification Chart	page	11
Operating Instructions – Manual	page	12
Operating Instructions – Millivolt	page	14
Troubleshooting Guide	page	15
Replacement Parts List – Millivolt	page	16
Replacement Parts List – Manual	Page	18

GENERAL INFORMATION

These Dual-Listed Gas Log Appliances incorporate unitized ceramic fiber logs which glow realistically when the appliance is operating.

The gas log sets covered in this document are heater rated units. These units are equipped with either a standard manual gas valve or a millivolt gas valve. The control knob is set to the desired position, which maintains a continuous gas burning rate.

A spark ignition system (piezo) allows the gas pilot to be lit without the use of matches or batteries and permits operation of the heater during a power outage.

These appliances are equipped with a specially designed pilot utilizing an oxygen depletion sensor (ODS) which responds to the amount of oxygen available in the room and shuts the heater off before the oxygen level drops below 18%. The pilot can be relit only when fresh air is available. Refer to the Combustion and Ventilation Air section.

WARNING: THIS APPLIANCE IS FOR INSTALLATION ONLY IN A SOLID FUEL BURNING FIREPLACE WITH A WORKING FLUE OR AN APPROVED VENTLESS FIREBOX ENCLOSURE.

Minimum Fireplace (Firebox) Size

Log Set	Height	Depth	Width
PVFGGL-18	18"	14"	30" Front 20 ½" Rear
PVFGGL-24	18"	14"	35" Front 24 ½" Rear

Table 1

Do not install these Dual-Listed Gas Log Appliances in a bedroom or a bathroom as all units exceed maximum allowable BTU/hr input of 10,000.

Check the inventory list to be sure that you have all the necessary parts in usable condition. Also check for concealed damage.

Inventory

Dual-Listed gas log appliance
Installation and Operating Instructions
Warranty Form

Tools and Supplies Normally Required

External regulator (Propane models only)
Manual shut-off valve
Sediment trap
Piping complying with local codes
Pipe compound
Pipe wrench
Tee joint
Screwdriver

IMPORTANT SAFETY INFORMATION

INSTALLER: PLEASE LEAVE THESE INSTRUCTIONS WITH THE OWNER.

OWNER: PLEASE RETAIN THESE INSTRUCTIONS FOR FUTURE REFERENCE

IMPORTANT: READ THESE INSTALLATION INSTRUCTIONS CAREFULLY BEFORE INSTALLING OR TRYING TO OPERATE THIS APPLIANCE.

WARNING: FAILURE TO COMPLY WITH THE INSTALLATION AND OPERATING INSTRUCTIONS PROVIDED IN THIS DOCUMENT WILL RESULT IN AN IMPROPERLY INSTALLED AND OPERATING APPLIANCE, VOIDING ITS WARRANTY. ANY CHANGE TO THIS APPLIANCE AND/OR ITS OPERATING CONTROLS IS DANGEROUS. IMPROPER INSTALLATION OR USE OF THIS APPLIANCE CAN CAUSE SERIOUS INJURY OR DEATH FROM FIRE, BURNS, EXPLOSION OF CARBON MONOXIDE POISONING.

Carbon Monoxide Poisoning: Early signs of carbon monoxide poisoning are similar to the flu with headaches, dizziness and/or nausea. If you have these signs, obtain fresh air immediately. Turn off the gas supply to the appliance and have it serviced by a qualified professional, as it may not be operating correctly.

- Due to high temperatures, the appliance should be located out of traffic and away from furniture and draperies.
- Children and adults should be alerted to the hazard of high surface temperature and should stay away to avoid burns or clothing ignition.
- Young children should be carefully supervised when they are in the same room with the appliance.
- Do not place clothing or other flammable material on or near the appliance.
- Any safety screen or guard removed for servicing the appliance must be replaced prior to operating the appliance.
- Installation and repair should be done by a qualified service person. The appliance should be inspected before use and at least annually by a professional service person. More frequent cleaning may be required due to excessive lint from carpeting, bedding material, etc. It is important that control compartments, burners and circulating air passageways of the appliance be kept clean.
- Allow the appliance to cool before servicing. Always shut off the gas to the appliance while performing service work.
- Do not install the appliance in a bedroom or bathroom.

- The installation must conform with local codes or, in the absence of local codes with the National Fuel Gas Code, ANSI Z223.1.

- The appliance and its individual shut-off valve must be disconnected from the gas supply piping system while performing any tests of the gas supply piping system at pressures in excess of ½ psig.

- The appliance must be isolated from the gas supply piping system by closing its individual manual shut-off valve during any pressure testing of the gas supply piping system at test pressures equal to or less than ½ psig.

- Keep appliance area clear and free from combustible materials, gasoline and other flammable vapors and liquids.

- Do not use this appliance if any part has been under water. Immediately call a qualified service technician to inspect the appliance and to replace any part of the control system and any gas control which has been under water.

- Input ratings are shown in BTU per hour and are for elevations up to 2,000 feet. Do not install this appliance at an elevation above 2,000 feet if the gas supply has not been derated for that elevation. Consult your local gas supplier. (For operation at elevations above 2,000 feet, equipment ratings shall be reduced at the rate of 4 percent for each 1,000 feet above sea level before selecting appropriately sized equipment.)

- Ensure that the appliance is clean when operating. Excessive dust accumulation on the burner and/or logs will increase the amount of carbon monoxide formation and could lead to carbon monoxide poisoning and/or death.

CODES

Adhere to all local codes or in their absence the latest edition of The National Fuel Gas Code ANSI Z223.1 or NFPA54 which can be obtained from The American National Standards Institute, Inc. (1430 Broadway, New York, NY, 10018) or National Fire Protection Association, Inc. (Batterymarch Park, Quincy, MA, 02269).

State or local codes may only allow operation of this appliance (manual version only) in a vented configuration. Check your state or local codes.

Serene Heat Gas Log appliances are certified by Warnock Hersey to ANSI Z21.11.2 unvented room heaters standard. These gas log appliances may be used as a space heat source for a room in conjunction with an approved unvented firebox.

Additionally, these units are design certified by Warnock Hersey to ANSI 21.60 as a vented gas log set.

As such, these units may be used as a vented gas log set in any wood-burning fireplace that has been properly constructed to code, and in the case of factory built fireplaces, installed in compliance with manufacturers listing and installation instruction.

Use of the log sets covered by this manual in a properly vented wood-burning fireplace which has had the damper blocked open as detailed below, preclude consideration of the combustion and ventilation air and clearance to combustible restrictions discussed herein.

When local codes require the damper to be fixed open, a damper stop must be installed to prevent full closure of the fireplace damper and provide a minimum 29 square inch flue opening at all times.

If damper clamp is not available, the damper may be fixed open in the following manner. Drill a hole in the end of the damper. Screw in a bolt of sufficient size and adjust to provide the minimum 29 square inches of flue opening.

COMBUSTION AND VENTILATION AIR

This appliance shall not be installed in a confined space or unusually tight construction unless provisions are provided for adequate combustion and ventilation air.

The National Fuel Gas Code defines a confined space as a space whose volume is less than 50 ft³ per 1,000 BTU/Hr (4.8 m³ per kw) of the aggregate input rating of all appliances installed in that space and an unconfined space as a space whose volume is not less than 50 ft³ per 1,000 BTU/Hr (4.8 m³ per kw) of the aggregate input rating of all appliances installed in that space. Rooms communicating directly with the space in which the appliances are installed, through openings not furnished with doors, are considered a part of the unconfined space.

Unusually tight construction is defined as construction where:

a. wall and ceilings exposed to the outside atmosphere have a continuous water vapor retarder with a rating or one perm or less with openings gasketed or sealed, and

b. weather stripping has been added on operable windows and doors, and

c. caulking or sealants are applied to areas such as joints around window and door frames, between sole plates and floors, between wall-ceiling joints, between wall panels, at penetrations for plumbing, electrical, and gas lines, and at other openings.

Use the following equations to determine if you have a confined or unconfined space.

1. Determine the volume of space — ft³.

Length x Width x Height = _____ ft³
(Include adjoining rooms with doorless passageways or ventilation grills between rooms.)

Example: 24' (L) x 16' (W) x 8' (H) = 3072 ft³

2. Divide the volume of space by 50 ft³ to determine the maximum BTU/Hr the space can support.

_____ (volume of space – ft³) / 50 ft³ =
(Maximum BTU/Hr the space can support)

Example: 3072 ft³ / 50 ft³ = 61.44
or 61,440 BTU/Hr the space can support.

3. Add the BTU/Hr of all the fuel burning appliances in the space.

Vent-Free Heater	_____	BTU/Hr
Gas Appliance #1*	_____	BTU/Hr
Gas Appliance #2	+ _____	BTU/Hr
Total =	_____	BTU/Hr

Example:

Vent-Free Heater	32,000	BTU/Hr
Gas Appliance #1 (water heater)	35,000	BTU/Hr
Total =	67,000	BTU/Hr

* Do not include Direct-Vent Gas Appliances. Direct-Vent is sealed combustion and draws combustion air from the outdoors.

4. Compare the maximum BTU/Hr the space can support with the actual amount of BTU/Hr used.

_____	BTU/Hr
	(max. the space can support)
_____	BTU/Hr
	(actual amount of BTU/Hr used)

Example:

61,440	BTU/Hr
	(max. the space can support)
67,000	BTU/Hr
	(actual amount of BTU/Hr used)

The space in the above example is a confined space because the actual BTU/Hr used is more than the maximum BTU/Hr the space can support. You must provide additional fresh air.

Your options are:

- a. Rework equations adding the space of adjoining room(s). If the extra volume provides an unconfined space, then remove door or add ventilation grills between rooms. Refer to National Fuel Gas Code, ANSI Z223.1, Section 5.3.
- b. Vent room directly to the outdoors. Refer to National Fuel Gas Code, ANSI Z223.1, Section 5.3.
- c. Install a lower BTU/Hr appliance, such as a 24,000 BTU/Hr, to make the area an unconfined space.

If the actual BTU/Hr used is less than the maximum BTU/Hr the space can support, then the space is an unconfined space. You will need no additional fresh air ventilation for an unconfined space.

WARNING: IF THE AREA IN WHICH THE APPLIANCE MAY BE OPERATED IS SMALLER THAN THAT DEFINED AS AN UNCONFINED SPACE OR IF THE BUILDING IS OF UNUSUALLY TIGHT CONSTRUCTION, PROVIDE ADEQUATE COMBUSTION AND VENTILATION AIR BY ONE OF THE METHODS DESCRIBED IN THE NATIONAL FUEL GAS CODE, ANSI Z223.1, SECTION 5.3 OR APPLICABLE LOCAL CODES.

PREINSTALLATION

WARNING: BEFORE INSTALLING IN A SOLID FUEL BURNING FIREPLACE, THE CHIMNEY FLUE AND FIREBOX MUST BE CLEANED OF SOOT, CREOSOTE, ASHES AND LOOSE PAINT BY A QUALIFIED CHIMNEY CLEANER.

CAUTION: APPLIANCES CREATE WARM AIR CURRENTS. THESE CURRENTS MOVE HEAT TO WALL SURFACES NEXT TO APPLIANCE. INSTALLING APPLIANCE NEXT TO VINYL OR CLOTH WALL COVERINGS OR OPERATING APPLIANCE WHERE IMPURITIES IN THE AIR (SUCH AS TOBACCO SMOKE) EXISTS, MAY DISCOLOR WALLS.

Note: Illustrations shown in this manual reflect "typical" installations with nominal dimensions and are for reference only. Actual installations may vary due to individual design preferences. However, always maintain minimum clearances to combustible materials and do not violate any specific installation requirements. Refer to Figures 1 through 7 for clearances.

Note: The following steps represent the normal sequence of installation. Each installation is unique, however, and might require a different sequence.

- Turn off gas supply to the fireplace or firebox.
- Position appliance in fireplace or firebox.
- Connect gas line.
- Secure appliance.
- Operate the appliance and check operation.

Check Gas Type

This appliance can only be connected to the gas type specified on the appliance rating plate. **This appliance can not be modified in the field for a different gas type.** If the gas supply differs, **DO NOT INSTALL** the appliance. Contact your dealer to obtain the correct appliance.

CLEARANCES

WARNING: DO NOT INSTALL THIS GAS APPLIANCE:

- IN SLEEPING QUARTERS, BATHROOMS, A MOBILE HOME, OR A RECREATIONAL VEHICLE.
- WHERE CURTAINS, FURNITURE, CLOTHING OR OTHER FLAMMABLE OBJECTS ARE LESS THAN 42" FROM THE FRONT OF THE GAS APPLIANCE.
- IN HIGH TRAFFIC AREAS.
- IN WINDY OR DRAFTY AREAS.

VENT FREE APPLICATIONS

Ensure the minimum clearances shown in Figures 1 through 7 are maintained. Left and right clearances are determined when facing the front of the appliance.

Follow these instructions carefully to ensure safe installation. Failure to follow these requirements may create a fire hazard.

Step 1. Sidewall Clearances: The sides of the fireplace opening must be at least 16" from any combustible side wall (Figure 1).

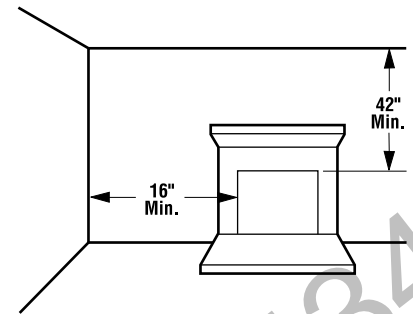

Figure 1

Step 2. Ceiling Clearance: The ceiling must be at least 42" from the top of the appliance opening (Figure 1).

Step 3. Noncombustible materials (minimum requirements): To install the appliance without wood mantels, shelves or other combustible projections directly above the opening of the fireplace (firebox) refer to Figure 2 and Table 2. Note that at least 8" of noncombustible material must be installed above the appliances described in this manual.

Noncombustible materials, such as slate and marble, must be at least 1/2" thick.

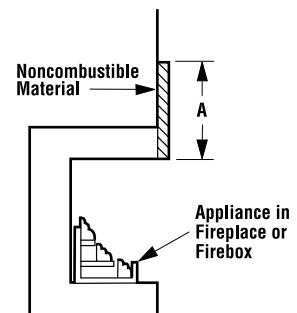

Figure 2

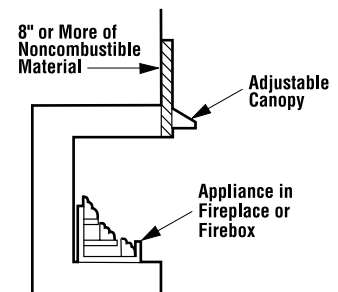

Figure 3

Noncombustible Material Requirements with No Mantel Installed

(A) Noncombustible Material Measurement	Requirements for Safe Installation
12" or more	Adjustable canopy not required.
8" minimum to 12"	Install adjustable canopy.
Less than 8"	Extend noncombustible material to at least 8" and install adjustable canopy (Figure 3), or Extend noncombustible material to a height of at least 12".

Table 2

Noncombustible Material Heights and Mantel Location

Noncombustible Material Measurement	Requirements for Safe Installation with Wood Mantel, Shelf or Other Combustible Projection
12" or more	Adjustable canopy not required. Observe profiles shown in Figure 4.
8" minimum to 12"	Install adjustable canopy and observe profiles shown in Figure 5. or Extend heat resistant material to at least 12" and observe profiles shown in Figure 4.

Table 3

Step 4. Wood mantel, shelf or combustible projection requirements: To install a wood mantel, shelf or other combustible projection directly above the fireplace (firebox), refer to Table 3 and to Figures 4 and 5 for installation profiles.

If your mantel profile is unsafe, you may either:

- Raise the mantel to an acceptable height, or
- Remove the mantel.

Example: The bottom of the mantel may project from the wall a maximum of 2 1/2" at a minimum of 28" above the opening. The top shelf of the mantel may project a maximum of 6" at a minimum of 34 1/2" above the opening.

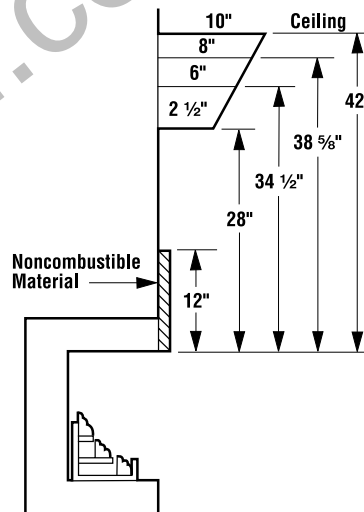

Figure 4

Example: The bottom of the mantel may project from the wall a maximum of 2 1/2" at a minimum of 8" above the opening. The top shelf of the mantel may project a maximum of 6" at a minimum of 14 1/2" above the opening.

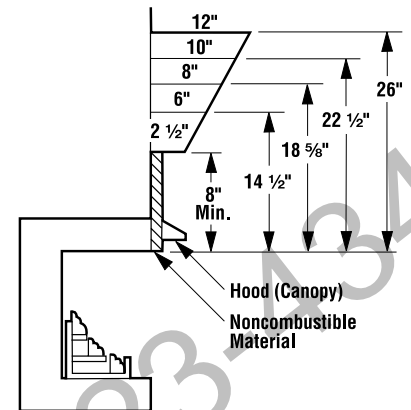

Figure 5

Step 5. Floor clearance: If combustible flooring materials, such as carpeting or asphalt tile, are to be located within 14" of the fireplace or firebox opening, the appliance base must be at least 5" above the combustible flooring material (Figure 6).

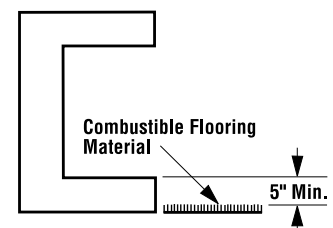

Figure 6

The appliance base may be lower than 5" above the combustible flooring materials if the combustible flooring materials are more than 14" from the fireplace or firebox opening (Figure 7).

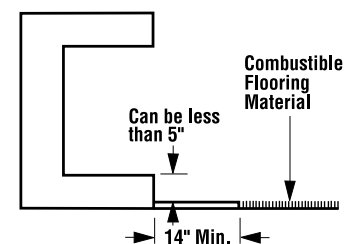

Figure 7

INSTALLATION

WARNING: DO NOT ALLOW FANS TO BLOW DIRECTLY INTO THE FIREPLACE. AVOID ANY DRAFTS THAT ALTER BURNER FLAME PATTERNS.

WARNING: DO NOT USE A BLOWER INSERT, HEAT EXCHANGER INSERT OR OTHER ACCESSORY NOT APPROVED FOR USE WITH THIS APPLIANCE.

This appliance must not be operated without a fireplace screen installed. Fireplace screens must not impair the free flow of combustion air to the appliance.

Do not burn solid fuels in any fireplace equipped with this Dual-Listed gas appliance.

WARNING: INSTALLED DECORATIVE GLASS DOOR ENCLOSURES MUST BE FULLY OPENED WHEN OPERATING THIS DUAL-LISTED GAS APPLIANCE.

Any outside air ducts and/or ash dumps that are part of the original solid fuel burning fireplace system must be fully closed and sealed at the time of installation of this Dual-Listed gas appliance.

WARNING: SPECIAL CARE IS REQUIRED IF YOU ARE INSTALLING THE UNIT INTO A SUNKEN FIREPLACE. YOU MUST RAISE THE FIREPLACE FLOOR TO ALLOW ACCESS TO GAS LOG CONTROLS. THIS WILL INSURE ADEQUATE AIR FLOW AND GUARD AGAINST SOOTING. RAISE THE FIREPLACE FLOOR USING NONCOMBUSTIBLE MATERIALS.

A qualified gas appliance installer must install this appliance.

Check gas type: The gas supply must be the same as stated on the appliance's rating plate. If the gas supply is different, DO NOT INSTALL the appliance. Contact your dealer for the correct model.

Step 1. Placement of Appliance – Center the appliance in the fireplace or firebox. Make certain the grate front feet sit inside the front edge of the fireplace or firebox, and that there is adequate clearance around the appliance for access and operation.

Step 2. Connecting Gas Line – A qualified gas appliance installer must connect the dual-listed gas appliance to the gas supply.

Consult all local codes.

Route gas line using techniques and materials prescribed by local and/or national codes. Only use pipe of ½" or greater diameter to allow full gas volume to the gas fireplace. Undue pressure loss will occur if the pipe is too small.

An ANSI approved manual shut-off valve and union must be installed upstream of the appliance within the fireplace cavity when rigid pipe is used.

Ensure that a sediment trap is installed upstream of the appliance within the structures piping system to prevent moisture and contaminants from passing through the pipe to the appliance controls and burners (Figure 8). Failure to do so could prevent the appliance from operating reliably.

IMPORTANT: HOLD APPLIANCE REGULATOR WITH A WRENCH TO PREVENT MOVEMENT WHEN CONNECTING TO INLET PIPING

An external regulator must be used on all propane (L.P.G.) appliances, in addition to the regulator fitted to the appliance, to reduce the supply tank pressure to 13" w.c. (maximum).

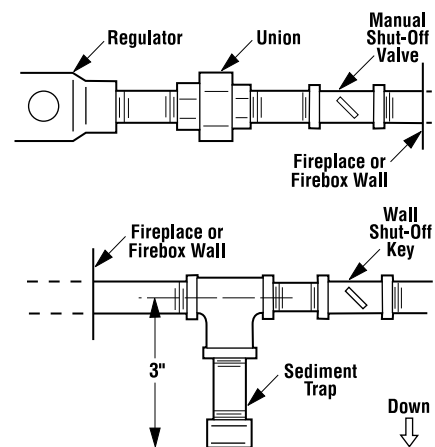

Figure 8

WARNING: CONNECTING DIRECTLY TO AN UNREGULATED PROPANE TANK MAY CAUSE AN EXPLOSION.

The appliance gas inlet connection is ¾" NPT at the regulator/valve, located on the left side facing the appliance. If a right side connection is required, the connection pipe may be piped under the rear of the appliance to end at the left hand side for connection to the inlet.

When tightening up the joint to the regulator hold the regulator securely with a wrench to prevent the regulator from moving.

Checking Gas Connections: Test all gas joints from the gas meter to the gas appliance regulator for leaks using soap and water solution after completing connection. **DO NOT USE AN OPEN FLAME.**

A. Mix a 50% dish soap, 50% water solution.

B. Light the appliance (see safety and lighting instructions on pages 12 and 14).

C. Brush all joints and connections with the soapy water solution to check for leaks. If bubbles are formed, or gas odor is detected, turn the gas control knob to the "OFF" position. Either tighten or refasten the leaking connection and retest as described above.

D. When the gas lines are tested and leak free, observe the individual tongues of flame on the burner. Make sure all ports are open and producing flame evenly across the burner. If any ports are blocked, or partially blocked, clean out the ports.

Gas Pressure Check

The appliance regulator controls the burner pressure which should be checked at the pressure test point (¼" NPT plugged tap) located on the manual control valve body (on Manual models) or on the control valve itself (on Millivolt models), identified OUT for the manifold side and IN for inlet pressure (see Figure 9). Ensure operating pressures are within the limits specified in the technical chart on page 10.

The pressure should be checked with the gas appliance burning and the control set to high.

Manual Valve

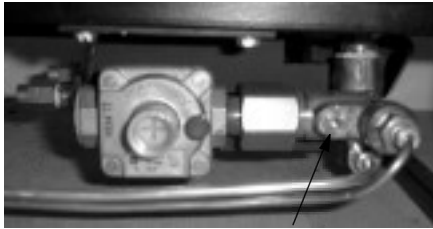

Pressure Test Point

Millivolt Valve

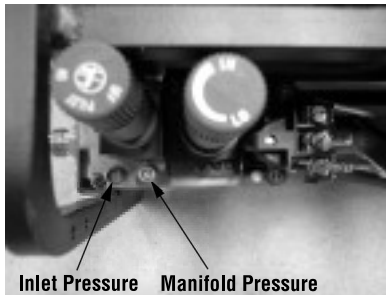

Inlet Pressure Manifold Pressure

Figure 9

The pressure regulator on manual models is preset and locked to avoid tampering. If the pressure is not as specified in the Technical Details Chart on page 10, replace the regulator with P/N 67L0501 for natural gas and P/N 67L0601 for propane (L.P.G.) heaters.

Replace the test point plug after pressure measurement ensuring no gas leaks.

Step 4. Placing the Logs

WARNING: DO NOT ADD EXTRA LOGS OR ORNAMENTS SUCH AS PINE CONES, VERMICULITE OR ROCK WOOL. USING THESE ADDED ITEMS CAN CAUSE SOOTING.

WARNING: DO NOT PLACE ANY LAVA ROCK ON LOGS OR BURNERS. THIS MAY CAUSE SOOTING. ONLY PLACE LAVA ROCK ON FLOOR OF FIREPLACE.



Manual Log Set



Millivolt Log Set

Figure 10

WARNING: FAILURE TO POSITION THE PARTS IN ACCORDANCE WITH FIGURE 10 OR FAILURE TO USE ONLY PARTS SPECIFICALLY APPROVED WITH THIS APPLIANCE MAY RESULT IN PROPERTY DAMAGE OR PERSONAL INJURY.

Periodically check the positioning of all logs.

Flame Appearance

REFER TO THE OPERATING INSTRUCTIONS LOCATED AT THE BACK OF THIS MANUAL BEFORE LIGHTING THE APPLIANCE TO OBSERVE THE FLAMES.

Flames from the pilot, front and rear burner should be visually checked as soon as the appliance is installed. In addition a periodic visual check of the flames should be made. The pilot flame should always be present when the appliance is in operation (Figure 11).

WARNING: NO ADJUSTMENTS ARE TO BE MADE TO THE ODS PILOT SYSTEM. TAMPERING WITH THIS SYSTEM CAN BE EXTREMELY HAZARDOUS.

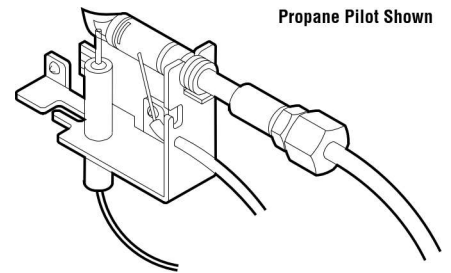

Propane Pilot Shown

Figure 11

An incorrect pilot flame pattern is shown in Figure 12. This pilot flame will cause the thermocouple to cool. When the thermocouple cools, the log set will shut off. If pilot flame pattern is incorrect, or if log set shuts off, contact your service technician.

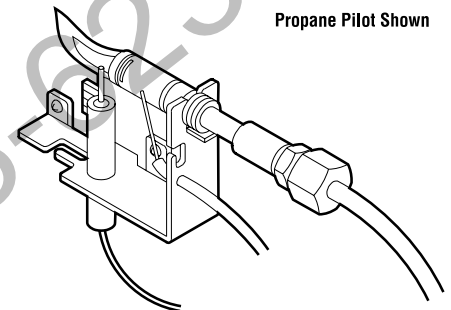

Propane Pilot Shown

Figure 12

In normal operation, at full rate, after 15 minutes the following flame appearance should be observed:

Burner And Flame Characteristics

The Serene Heat Gas Log Set features a new concept in integrated burner and log design. The flames from the burner travel horizontally through the log set and emerge at the middle and rear of the set against the back log wall configuration.

The flames are slightly blue off the burner and as they progress through the log set, they change to a light yellow color. Yellow decorative flames are visible as the flames exit the log set.

The base of the log set and the underside of the top log glows a brilliant red. For an example see Figure 13.



Figure 13

OPERATION AND CARE OF YOUR APPLIANCE

1. Appliance operation may be controlled through the ON/OFF unit rocker switch, located in the bottom front of the appliance, or through a remotely located optional wall switch or wall thermostat.

2. When lit for the first time, the appliance will emit a slight odor for an hour or two. This is due to the “burn-in” of the internal paints and lubricants used in the manufacturing process. For the first few hours, operate the appliance with doors and windows open to encourage the dissipation of odor.

CLEANING AND SERVICING

WARNING: TURN OFF THE APPLIANCE AND ALLOW TO COOL BEFORE CLEANING.

CAUTION: YOU MUST KEEP CONTROL AREAS, BURNERS AND CIRCULATING AIR PASSAGEWAYS OF FIREPLACE CLEAN. INSPECT THESE AREAS OF FIREPLACE BEFORE EACH USE. HAVE FIREPLACE AND CHIMNEY (IF APPLICABLE) INSPECTED YEARLY BY A QUALIFIED SERVICE PERSON. FIREPLACE MAY NEED MORE FREQUENT CLEANING DUE TO EXCESSIVE LINT FROM CARPETING, BEDDING MATERIAL, ETC.

Only limited cleaning will be required under the normal use of the appliance. Dust the front grate, the top of the piezo cover and the control knob occasionally. Do not use cleaning fluids to clean the logs or any other part of the appliance.

Remove the log set, gently handling at each end. Use a vacuum cleaner to remove loose particles from the base and from around the burners. Gloves are recommended to prevent the fibers from pricking your skin. If the skin is pricked, wash gently with soap and water. Replace the log set.

If, after a period of use, the flames start to exhibit unusual shapes and behavior, or the burners fail to ignite smoothly, then the burner holes may require some cleaning. If this happens, it is preferable to contact your nearest authorized service technician to get the appliance serviced.

REPLACEMENT PARTS

An expanded view of the appliance with numbered parts and a parts list can be found on pages 16 through 19. All parts should be ordered through your distributor or dealer. Parts will be shipped at prevailing prices at time of order.

When ordering repair parts, always give the following information:

1. The model number of the appliance.
2. The serial number of the appliance.
3. The part number.
4. The description of the part.
5. The quantity required.
6. The installation date of the appliance.

If you encounter any problems or have any questions concerning the installation of this dual-listed gas appliance, please contact your distributor. For the name of your nearest distributor contact:

LENNOX HEARTH PRODUCTS
1110 West Taft Avenue
Orange, CA 92865

ACCESSORY COMPONENTS (Millivolt Models Only)

All options are available in kit form, are easy to install and are packaged complete with all required parts and instructions. Some of the option kits need to be fitted prior to completing the installation of the appliance. The following paragraphs detail the kit options available.

The appliances covered in this manual are heater rated and produce a great deal of heat. Decorative brass trim pieces and hoods may tarnish because of their proximity to the heater opening and front face. Tarnishing of these pieces is normal, unavoidable and should be expected.

Standard Remote Control System (Model RCL)

The Model RCL (Standard) Remote Control System, features a simplistic on/off control function for the fireplace. This model includes a hand-held transmitter, a remote receiver with wall-mount coverplate and all hardware required to install the unit. The remote receiver can be wall or hearth mounted.

The transmitter has ON and OFF functions that are activated by pressing either button on the face of the transmitter. When a button on the transmitter is pressed, a signal light illuminates briefly to verify that a signal has been sent.

The Model RCL is designed to operate with all millivolt ignition systems, as well as electronic ignition systems. It may be installed with use for either natural or propane gas appliances. The RCL offers ease of installation and allows you to execute on-off commands to the log set effortlessly with one simple motion.

The Model RCL comes complete with detailed operating instructions.

Deluxe Remote Control System (Model RC-STAT)

The Model RCL-T (Deluxe) Remote Control System has all of the features of the standard system along with an added easy to read LCD screen which presents access to many enhancements, including; battery power level indicator, timer, mode of operation, thermostatic display including room temperature in either metric or English units, flame indicator and clock. Fully programmable, the Model RCL-T allows for virtual command over nearly all operational and temperature variables, using the hand held remote control transmitter.

The Model RCL-T (Deluxe) remote control system is installed in the same manner as the standard system, may be operated with electronic and millivolt systems with either natural or propane gas. The RCL-T comes complete with detailed operating instructions.

Wall Thermostat Kit*

A wall thermostat kit is available for use with these appliances. The wall thermostat is designed to be wired directly to the appliance millivolt gas control circuit and provide automatic On/Off control of the appliance to maintain a desired temperature within the room.

Wall Switch Kit*

An optional wall switch kit can be installed along with all vent-free appliances. The kit consists of a standard UL wall switch with cover plate. This kit provides for remote (wall) operation of the appliance. Replace the wall switch and cover plate of this kit with the components of the RCK and you can have true remote control of your vent-free appliance, turning it on and off from your favorite easy chair. The wall switch kit should be installed along with the appliance.

*Use 18GA, solid two conductor wire to connect these kits to the appliance.

ACCESSORY COMPONENTS

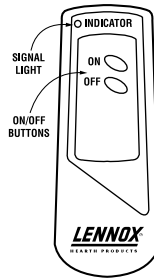

Remote Control System
Standard H0249 RCL

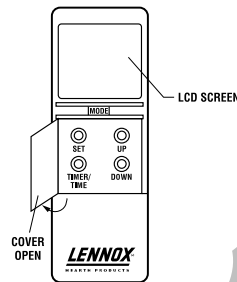

Remote Control System
Deluxe H0251 RCL-T

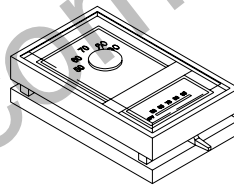

Thermostat 89L36 FWTK

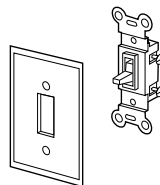

Wall Switch Kit 85L87 FWSK

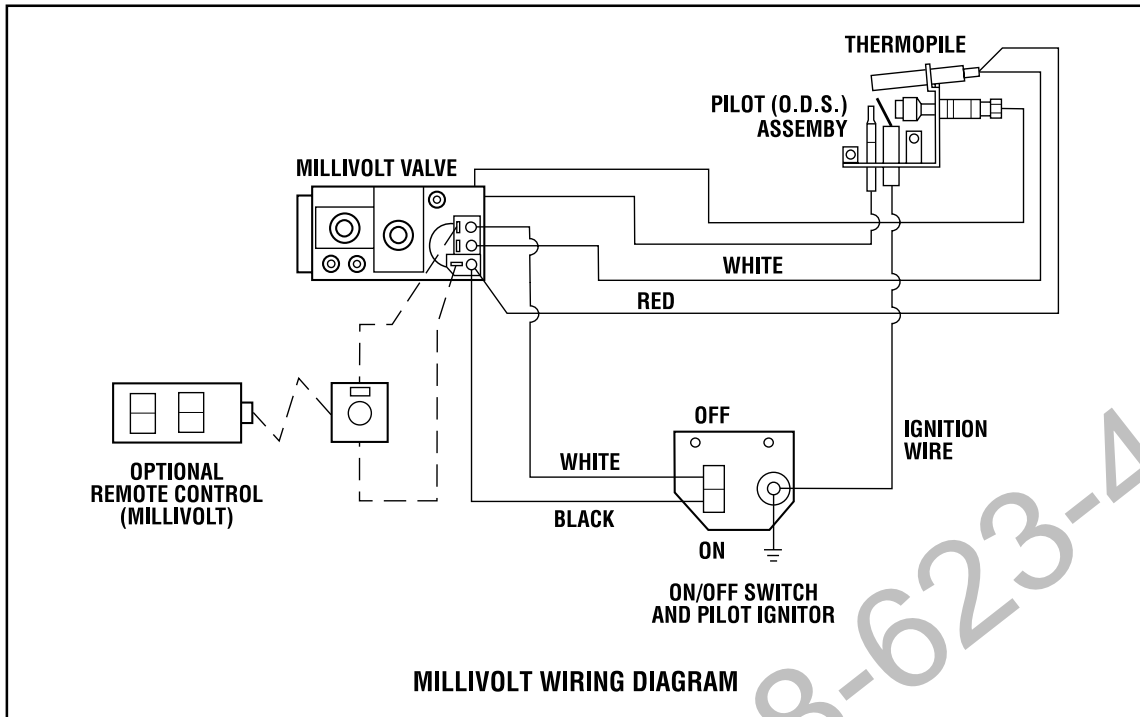

VENTED/UNVENTED GAS LOG APPLIANCE TECHNICAL CHART FOR MILLIVOLT LOG SET

Model No.	BTU/HR Input	Gas Type	Ignition	Regulator Pres. Setting	Gas Inlet Pressure*	Valve Operation	Orifice Size
PVFGL - 18VN	36,000 24,000	Natural	Piezo	1.6 – 3.5" w.c.	Max. 10.5" w.c. Min. 5.0" w.c.	Millivolt	#31
PVFGL - 18VP	34,000 26,000	Propane/LPG	Piezo	6.3 – 10.0" w.c.	Max. 13" w.c. Min. 11" w.c.	Millivolt	#50
PVFGL - 24VN	39,000 28,000	Natural	Piezo	1.6 – 3.5" w.c.	Max. 10.5" w.c. Min. 5.0" w.c.	Millivolt	0.125
PVFGL - 24VP	39,000 31,000	Propane/LPG	Piezo	6.3 – 10.0" w.c.	Max. 13" w.c. Min. 11" w.c.	Millivolt	#49

* For the purpose of input adjustment.

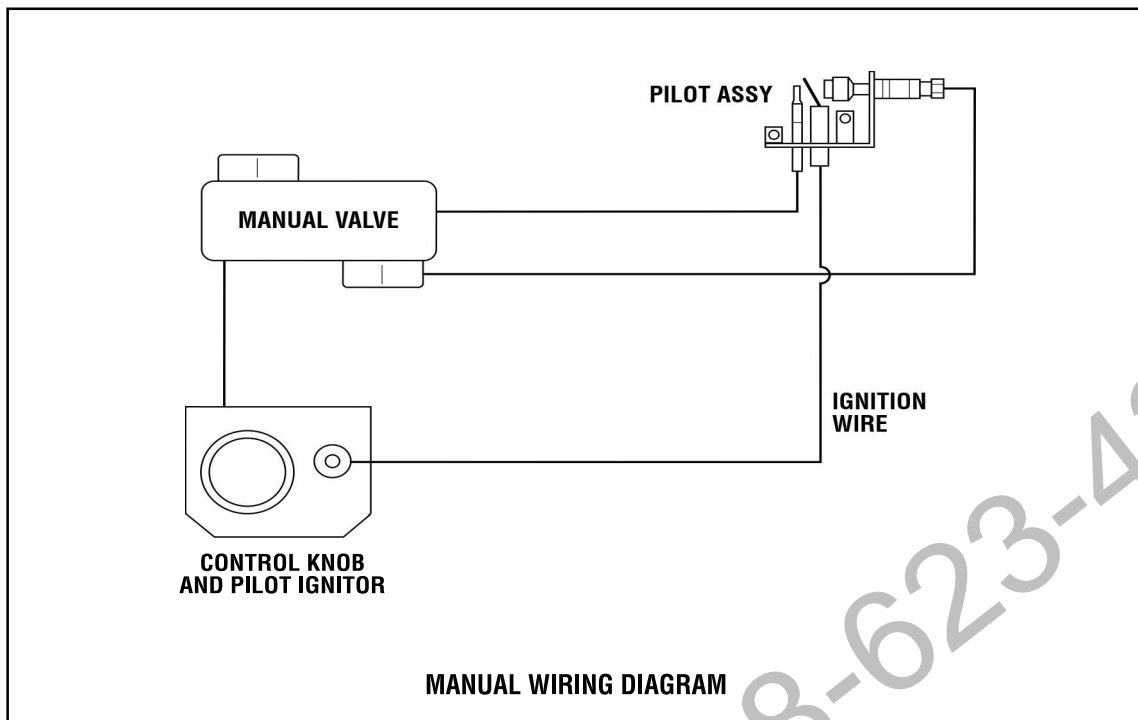

VENTED/UNVENTED GAS LOG APPLIANCE TECHNICAL CHART FOR MANUAL LOG SET

Model No.	BTU/HR Input	Gas Type	Ignition	Regulator Pres. Setting	Gas Inlet Pressure*	Valve Operation	Orifice Size
PVFGL - 18MN	36,000 21,000	Natural	Piezo	3.5" w.c.	Max. 10.5" w.c. Min. 5.0" w.c.	Manual	#31
PVFGL - 18MP	34,000 20,000	Propane/LPG	Piezo	10.0" w.c.	Max. 13" w.c. Min. 11" w.c.	Manual	#50
PVFGL - 24MN	39,000 22,000	Natural	Piezo	3.5" w.c.	Max. 10.5" w.c. Min. 5.0" w.c.	Manual	0.125
PVFGL - 24MP	39,000 20,000	Propane/LPG	Piezo	10.0" w.c.	Max. 13" w.c. Min. 11" w.c.	Manual	#49

* For the purpose of input adjustment.







OPERATING INSTRUCTIONS — MANUAL CONTROL MODELS

FOR YOUR SAFETY READ BEFORE LIGHTING

WARNING: IF YOU DO NOT FOLLOW THESE INSTRUCTIONS EXACTLY, A FIRE OR EXPLOSION MAY RESULT CAUSING PROPERTY DAMAGE, PERSONAL INJURY OR LOSS OF LIFE.

- A.** This heater has a pilot which must be lit by hand. When lighting the pilot, follow these instructions exactly.
- B. BEFORE OPERATING** smell all around the heater area for gas. Be sure to smell next to the floor because some gas is heavier than air and will settle on the floor.
- WHAT TO DO IF YOU SMELL GAS**
- Do not try to light any appliance.
 - Do not touch any electric switch; do not use any phone in your building.
 - Immediately call your gas supplier from a neighbor's phone. Follow the gas supplier's instructions.
 - If you cannot reach your gas supplier, call the fire department.
- C.** Use only your hand to push in or turn the gas control knob. Never use tools. If the knob will not push in or turn by hand, do not try to repair it, call a qualified service technician. Forced or attempted repair may result in a fire or explosion.
- D.** Do not use this heater if any part has been under water. Immediately call a qualified service technician to inspect the appliance and to replace any part of the control system and any gas control which has been under water.

LIGHTING INSTRUCTIONS

1. Stop! Read the safety information above.
2. Make sure manual shut-off valve is fully open.
3. Refer to *Figure 14* to locate gas control knob and piezo.
4. Depress control knob in and turn clockwise  to the "OFF" position (*Figure 15*).
5. Wait 5 minutes to clear out any gas. Then smell for gas, including near the floor. If you smell gas, **STOP!** Follow "B" in the safety information above. If you do not smell gas, go to the next step.
6. The pilot is located on the right side in front of the burner (*Figure 16*).
7. Depress control knob in and turn counterclockwise  to the "IGN" position (*Figure 17*). Press the control knob all the way in for 5 seconds.
8. With the control knob pressed in, push in and release the piezo igniter button to light the pilot.
9. Hold the control knob in for a further 10 seconds to prevent the flame failure detector from shutting off the gas while the probe is warming up.
10. Release the control knob while turning counterclockwise  to the preferred setting.
 - If the knob does not pop out when released, stop and immediately call your service technician or gas supplier.
 - If the pilot will not stay lit after several tries, depress and turn the gas control knob clockwise  to "OFF" and wait 30 seconds. Depress and turn knob counterclockwise  to "IGN" and press igniter button again. If your pilot does not relight depress and turn control knob clockwise  to "OFF" and call your service technician or gas supplier.
11. Wait 30 seconds before readjusting the heater when the control knob has been turned down to a lower setting.

Note: If you are running the heater for the first time it will be necessary to press the control knob all the way in for 30 seconds to allow air to bleed out of the gas piping.

TO TURN OFF GAS TO APPLIANCE

1. Depress and turn control knob clockwise  to the "OFF" position (*Figure 17*).

MANUAL MATCH LIGHTING PROCEDURE — EMERGENCY ONLY

1. If the pilot cannot be lit with the piezo igniter, the heater can be manually lit with a match.
2. With the right hand, depress and turn the control knob counterclockwise  to the "IGN" position. Hold in the knob.
3. Light the match and hold the flame to the end of the pilot and ignite the pilot.
4. Continue to hold control knob for an additional 10 seconds to insure pilot remains lit.
5. Release the control while turning control knob to desired setting.



Gas Control Knob Location

Figure 14

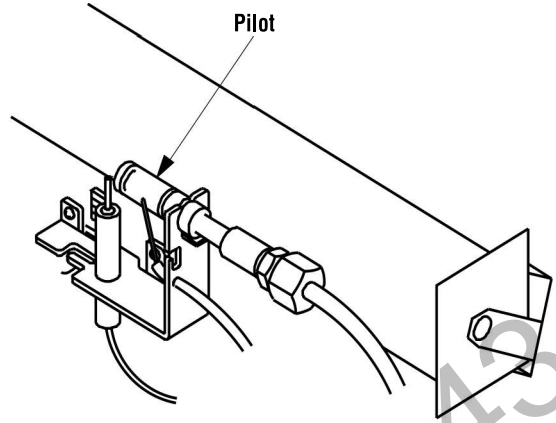

Pilot Location

Figure 16

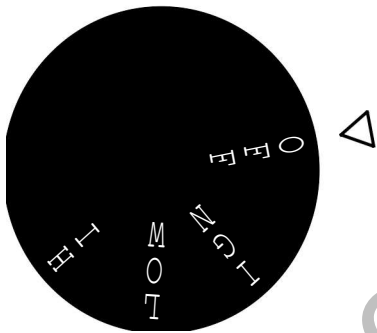

Turn Control Knob to "OFF" Position (Manual)

Figure 15

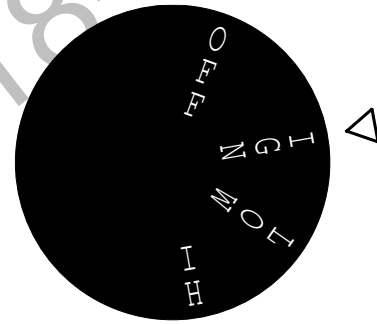

Turn Control Knob to "IGN" Position (Manual)

Figure 17

LIGHTING INSTRUCTIONS – MILLIVOLT

FOR YOUR SAFETY READ BEFORE LIGHTING

WARNING: IF YOU DO NOT FOLLOW THESE INSTRUCTIONS EXACTLY, A FIRE OR EXPLOSION MAY RESULT CAUSING PROPERTY DAMAGE, PERSONAL INJURY OR LOSS OF LIFE.

- A.** This appliance has a pilot which must be lighted with a piezo ignitor. When lighting the pilot, follow these instructions exactly.
- B. BEFORE OPERATING** smell all around the appliance area for gas. Be sure to smell next to the floor because some gas is heavier than air and will settle on the floor.

WHAT TO DO IF YOU SMELL GAS

- Extinguish any open flame.
- Open windows.
- Do not light any appliance.
- Do not touch any electrical switches.

- Do not use any phone in your building.
 - Immediately call your gas supplier from a neighbor's phone.
 - If your gas supplier cannot be reached, call the fire department.
- C.** Use only your hand to push in or turn the gas control knob. Never use tools. If the knob will not push in or turn by hand, do not try to repair it, call a qualified service technician. Force or attempted repair may result in a fire or an explosion.
- D.** Do not use this appliance if any part has been under water. Immediately call a qualified service technician to inspect the appliance and to replace any part of the control system and any gas control which has been under water.

LIGHTING INSTRUCTIONS

1. **STOP!** Read the safety information above on this page.
2. Access the lower control compartment.
3. Turn remote wall switch to "OFF."
4. Verify main line shut-off valve is open.
5. Push in gas control knob slightly and turn clockwise to "OFF."

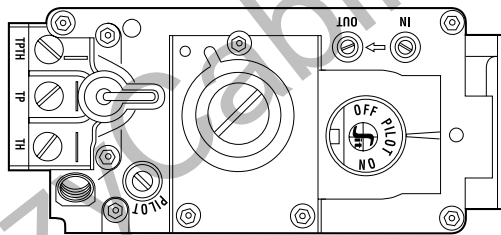

Note: Knob cannot be turned from "PILOT" to "OFF" unless the knob is pushed in slightly. Do not force.

6. Wait five (5) minutes to clear out any gas. If you then smell gas, STOP! Follow "B" in the safety information above on this page. If you do not smell gas, go to the next step.
7. Push in gas control knob slightly and turn counterclockwise to "PILOT."
8. Push in control knob all the way and hold in. Immediately light the pilot by triggering the spark ignitor (pushing the button) until pilot lights. Continue to hold the control knob in for about 1 ½ minutes after the pilot is lit. Release knob and it will pop back up. Pilot should remain lit. If it goes out, repeat steps 5 through 8.

- If knob does not pop up when released, stop and immediately call your service technician or gas supplier.

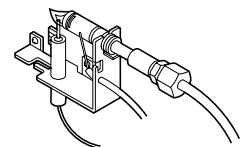

- If pilot will not stay lit after several tries, turn the control knob to "OFF" and call your service technician or gas supplier.

9. Turn gas control knob counterclockwise to "ON."
10. Close lower control compartment.

TO TURN OFF GAS TO APPLIANCE

1. Turn remote wall switch "OFF." The pilot will remain lit for normal service.
2. For complete shutdown, turn remote wall switch to "OFF."
3. Access the lower control compartment.
4. Depress gas control knob slightly and turn clockwise to "OFF." Do not force.
5. Close lower control compartment.

VENTED/UNVENTED TROUBLESHOOTING GUIDE

OBSERVED PROBLEM	POSSIBLE CAUSE	REMEDY
1. When igniter button is pressed, there is no spark at ODS/pilot.	A. Igniter electrode positioned wrong.	Replace igniter.
	B. Igniter electrode broken.	Replace igniter.
	C. Igniter electrode not connected to igniter cable.	Reconnect igniter cable.
	D. Igniter cable pinched or wet.	Free igniter cable if pinched by any metal or tubing. Keep igniter cable dry.
	E. Piezo igniter nut is loose.	Tighten nut.
	F. Broken igniter cable.	Replace igniter cable.
	G. Bad piezo igniter.	Replace piezo igniter.
2. Heater produces unwanted odors.	A. Heater burning vapors from paint, hair spray, glues, etc.	Ventilate room. Stop using odor-causing products while fireplace is running.
	B. Gas leak. See Warning statement on the front page.	Locate and correct all leaks.
3. Heater shuts off in use (ODS operates).	A. Not enough fresh air is available.	Open window and/or door for ventilation.
	B. Low line pressure.	Contact local gas company.
	C. ODS/pilot is partially clogged.	Clean ODS/pilot.
4. Gas odor even when control knob is in "OFF" position.	A. Gas leak. See Warning statement on the front page.	Locate and correct all leaks (see Checking Gas Connections, page 6).
	B. Control valve defective.	Replace control valve.
5. When igniter button is pressed, there is spark at ODS/pilot, but no ignition.	A. Gas supply turned off or manual shut-off valve closed.	Turn on gas supply or open manual shut-off valve.
	B. Control knob not in "PILOT" position.	Turn control knob to pilot position.
	C. Control knob not pressed in while in "PILOT" position.	Press in control knob while in pilot position.
	D. Air in gas lines when installed.	Continue holding down control knob. Repeat igniting operation until air is removed.
	E. ODS/pilot is clogged.	Replace ODS/pilot assembly or get it serviced.
	F. Gas regulator setting is not correct.	Replace gas regulator.
6. ODS/pilot lights, but flame goes out when control knob is released.	A. Control knob not fully pressed in.	Press in control knob fully.
	B. Control knob not pressed in long enough.	After ODS/pilot lights, keep control knob pressed in 30 seconds.
	C. Manual shut-off valve not fully open.	Fully open manual shut-off valve.
	D. Thermocouple connection loose at control valve.	Hand tighten until snug, then tighten ¼ turn more.
	E. Pilot flame not touching thermocouple, which allows thermocouple to cool, causing pilot flame to go out. This problem could be caused by one or both of the following: 1). Low gas pressure 2). Dirty or partially clogged ODS/pilot	1). Contact local gas company. 2). Replace ODS/pilot assembly or get pilot serviced.
	F. Thermocouple damaged.	Replace thermocouple.
	G. Control valve damaged.	Replace control valve.
7. Burner does not light after ODS/pilot is lit.	A. Burner orifice is clogged.	Clean burner or replace burner orifice.
	B. Burner orifice diameter is too small.	Replace burner orifice.
	C. Inlet gas pressure is too low.	Contact local gas company.
8. Delayed ignition of burner.	A. Manifold pressure is too low.	Contact local gas company.
	B. Burner orifice is clogged.	Clean burner or replace burner orifice.
9. Burner backfiring during combustion.	A. Burner orifice is clogged or damaged.	Clean burner or replace burner orifice.
	B. Burner damaged.	Replace burner.
	C. Gas regulator defective.	Replace gas regulator.
10. Slight smoke or odor during initial operation.	A. Vapors from paint or curing process of logs.	Problem will stop after a few hours of operation. Superior recommends running the heater with the excess ventilation for the first few hours.
11. Heater produces a whistling noise when burner is lit.	A. Turning control knob to "HI" position when burner is cold.	Turn control knob to "LO" position and let warm up for a minute.
	B. Air in gas line.	Operate burner until air is removed from line. Have gas line checked by local gas company.
	C. Dirty or partially clogged burner orifice.	Clean burner or replace burner orifice.

REPLACEMENT PARTS LIST (MILLIVOLT)

No.	Description	18N/18P Part No.	24N/24P Part No.
1.	Valve, Millivolt (Natural)	67L2101	67L2101
	Valve, Millivolt (Propane, L.P.G.)	67L2201	67L2201
*2.	Complete Log Assembly	(See Note)	(See Note)
*3.	Front Burner Assembly (Natural)	(See Note)	(See Note)
	Front Burner Assembly (Propane)	(See Note)	(See Note)
4.	Piezo Ignitor	10K8601	10K8601
5.	Pilot, Millivolt (Natural)	67L0301	67L0301
	Pilot, Millivolt (Propane, L.P.G.)	67L0401	67L0401
6.	Orifice, Burner (NG) #31 and .125	24M3201	24M5301
	Orifice, Burner (LP) #50 and #49	24M3301	24M5201
7.	Knob Extension, On/Off	69J7401	69J7401
8.	Knob Extension, Hi/Lo	69J9501	69J9501
9.	On/Off Switch	27K3001	27K3001
10.	Piezo Ignitor Cable	24M4001	24M4001

***NOTE:** The Log Set Assembly and Burner Assemblies listed are a *complete* assembly. If any part of the Log Set Assembly or Burner Assembly becomes damaged, the *entire* Log Set must be replaced. This is essential for the proper operation of the appliance.

REPLACEMENT PARTS (MILLIVOLT)

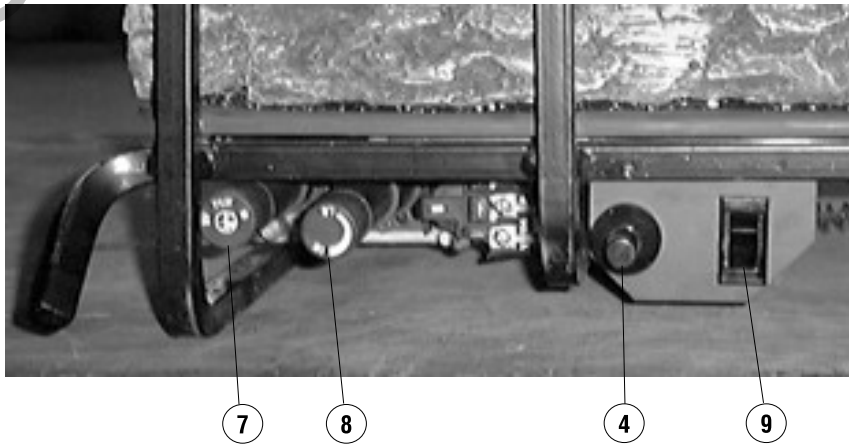
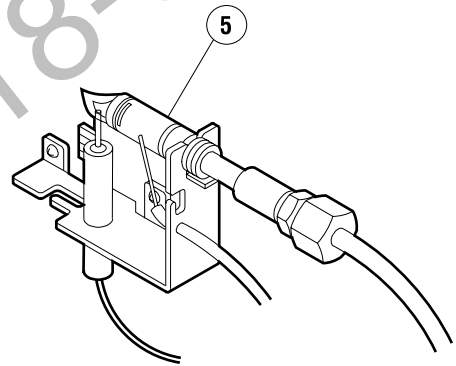

NOTE: DIAGRAMS & ILLUSTRATION NOT TO SCALE.

REPLACEMENT PARTS LIST (MANUAL)

No.	Description	18N/18P Part No.	24N/24P Part No.
1.	Valve, Manual (Natural)	13M9701	13M9701
	Valve, Manual (Propane, L.P.G.)	24M4101	24M4101
*2.	Complete Log Assembly	(See Note)	(See Note)
*3.	Front Burner Assembly (Natural)	(See Note)	(See Note)
	Front Burner Assembly (Propane)	(See Note)	(See Note)
4.	Piezo Ignitor	10K8601	10K8601
5.	Pilot, Manual (Natural)	13M9501	13M9501
	Pilot, Manual (Propane)	13M9601	13M9601
6.	Gas Regulator (Natural)	67L0501	67L0501
	Gas Regulator (Propane)	67L0601	67L0601
7.	Orifice, Burner (NG) #31 and .125	24M3201	24M5301
	Orifice, Burner (LP) #50 and #49	24M3301	24M5201
8.	Knob, On/Off	13M9901	13M9901
9.	Piezo Ignitor Cable	24M4001	24M4001

***NOTE:** The Log Set Assembly and Burner Assemblies listed are a *complete* assembly. If any part of the Log Set Assembly or Burner Assembly becomes damaged, the *entire* Log Set must be replaced. This is essential for the proper operation of the appliance.

REPLACEMENT PARTS (MANUAL)

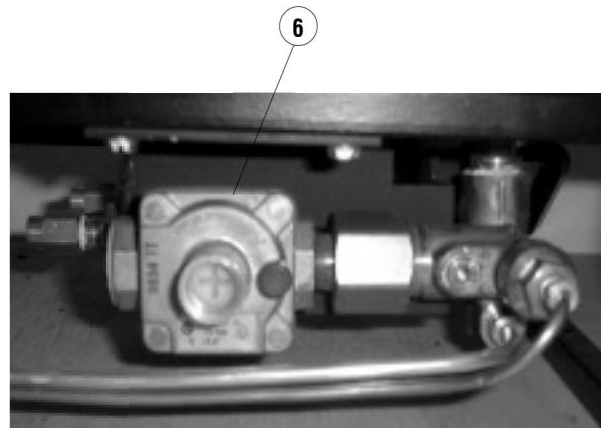
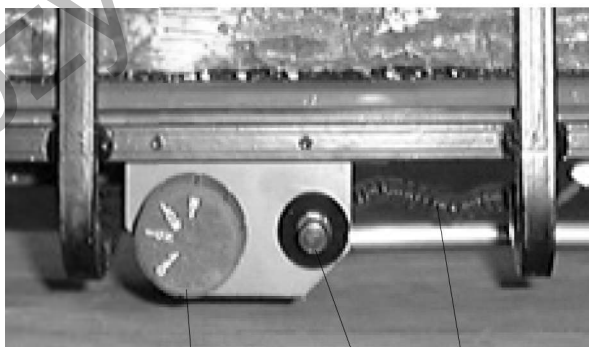
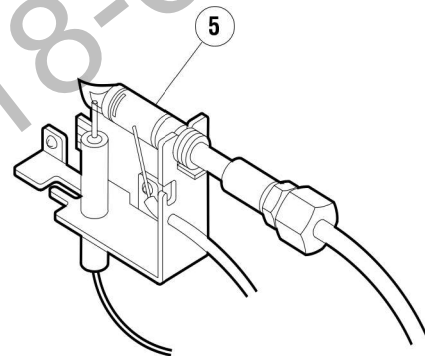
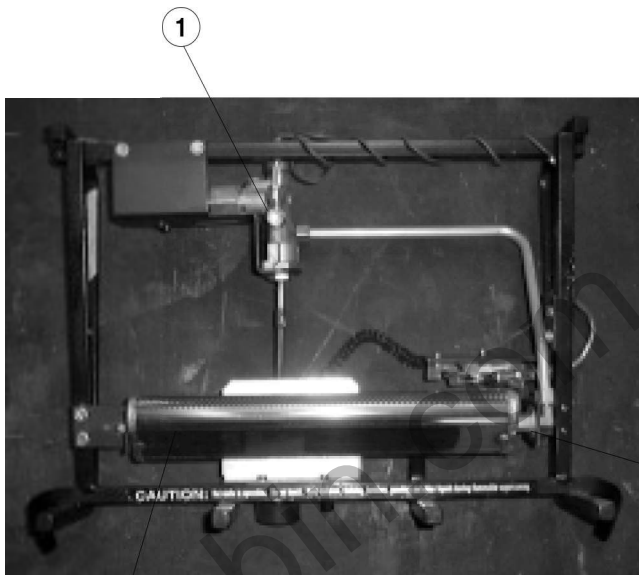

8

4

9

NOTE: DIAGRAMS & ILLUSTRATION NOT TO SCALE.

CozyCabin.com 518-623-4349

Lennox reserves the right to make changes at any time, without notice, in design, materials, specifications, prices and also to discontinue colors, styles and products. Consult your local distributor for fireplace code information.

Printed in U.S.A. © 2001 by Lennox
P/N 850,012M REV. A 03/2002

LENNOX[®]

HEARTH PRODUCTS

1110 West Taft Avenue
Orange, CA 92865