

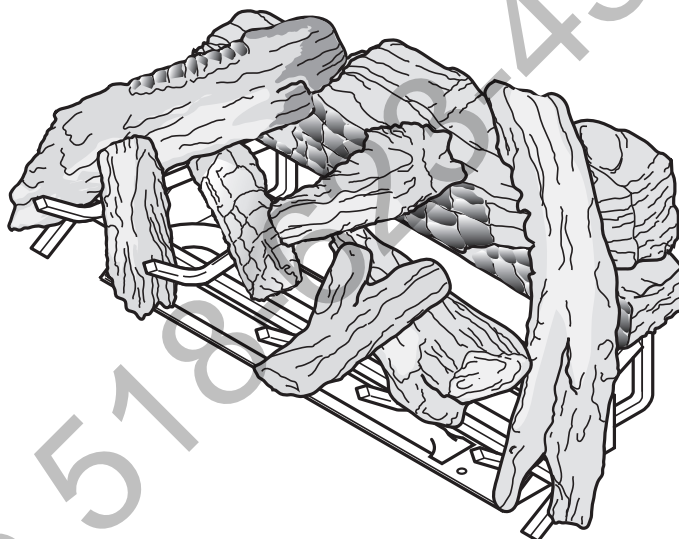

Vented Outdoor Gas Log Set Installation And Operating Instructions

Models:
VWFOD24, VWFOD30
Natural Gas or Propane/LPG
Control Type: Manual Match Light



WARNING

For Outdoor Use ONLY

WARNINGS

If the information in this manual is not followed exactly, a fire or explosion may result causing property damage, personal injury or loss of life.

- Do not store or use gasoline or other flammable vapors and liquids in the vicinity of this or any other appliance.
- **WHAT TO DO IF YOU SMELL GAS**
 - Do not try to light any appliance.
 - Do not touch any electrical switch; do not use any phone in your building.
 - Immediately call your gas supplier from a neighbor's phone. Follow the gas supplier's instructions.
 - If you cannot reach your gas supplier, call the fire department.
- Installation and service must be performed by a qualified installer, service agency or the gas supplier.

This gas log set is to be installed only in a solid-fuel burning fireplace with a working flue constructed of noncombustible material.

WARNING: Improper installation, adjustment, alteration, service or maintenance can cause injury or property damage. Read the installation, operating and maintenance instructions thoroughly before installing or servicing this equipment.



Approved for outdoor use

Approved to:
CSA-4.96
CSA-CR97-003 (NG Only)

INSTALLER: Leave this manual with the appliance.
CONSUMER: Retain this manual for future reference.

**Thank you and congratulations on your purchase of an
MHSC Gas Log Set**

PLEASE READ THE INSTALLATION AND OPERATION INSTRUCTIONS BEFORE USING THE APPLIANCE!

IMPORTANT: Read all instructions and warnings carefully before starting installation.

Failure to follow these instructions may result in a possible fire hazard and will void the warranty.

Important Safety Information 3

Product Features & Specifications 4

Fireplace & Hearth Dimensions 5
Installation in a Fireplace with Restrictive Barrier... 5

Installation..... 6
Damper Stop Installation 6
Check Gas Type 7
Install Gas Line..... 8

Log Placement 9
VWF24 Massive Oak Log 9
VWF30 Massive Oak Log 11
VWF24 American Oak Log 12
VWF30 American Oak Log 13
VWF30/24 Split River Oak Log 15
VWF36/30 Split River Oak Log 17
VWF24 Split Pine 18
VWF30 Split Pine 20
VWF30/24WP Weathered Pine Log 22
WF36/30WP Weathered Pine Log 24

Operating Instructions 25
Manual Match Control Lighting 25
Flame Appearance 26

Fireplace Draft Test 27

Cleaning and Servicing 28

Replacement Parts Lists 29
Assembly 29
Massive Oak Logs 30
American Oak Logs 31
Split River Oak Logs 32
Split Pine Logs 33
Weathered Pine Logs 34

Massachusetts Residents Only..... 35

Warranty 36

WARNING Never connect unit to private (non-utility) gas wells. This gas is commonly known as wellhead gas.



NATIONAL FIREPLACE INSTITUTE
NFI
CERTIFIED
www.nficertified.org

We recommend that our gas hearth products be installed and serviced by professionals who are certified in the U.S. by the National Fireplace Institute® (NFI) as NFI Gas Specialists.

VWFOD
Certified To
CSA-4.96
CSA - CR97-003 (NG Only)

WARNING This appliance is for installation only in a solid fuel burning fireplace (masonry fireplace or manufactured fireplace).

WARNING **FOR MASSACHUSETTS RESIDENTS ONLY:**
This product must be installed by a licensed plumber or gas fitter when installed within the Commonwealth of Massachusetts.

INSTALLER

Please leave these instructions with the appliance.

OWNER

Please retain these instructions for future reference.

IMPORTANT

Read these instructions carefully before installing or trying to operate this vent-free gas heater.

WARNING

- Any change to this heater or its controls can be dangerous.
- Improper installation or use of the heater can cause serious injury or death from fire, burns, explosion or carbon monoxide poisoning.
- Do not allow fans to blow directly into the fireplace. Avoid any drafts that alter burner flame patterns.
- Do not use a blower insert, heat exchanger insert or other accessory, not approved for use with this heater where applicable.

1. The installation, combustion and ventilation air must conform with local codes or, in the absence of local codes, with the National Fuel Gas Code, ANSI Z223.1, or the CSA-B149 Installation code (series). This unit complies with CSA-4.96 US and CR97-003, Outdoor Fireplaces for installation in solid-fuel burning fireplace.
 2. Installation and repair should be done by a qualified service person. MHSC Vented Gas Logs must be installed only in a masonry or a UL-127 solid-fuel fireplace with minimum venting requirements, see installation section.
 3. To prevent malfunction, gas log set and flue should be cleaned at least annually by a professional service person. More frequent cleaning may be required due to excessive lint from carpeting, etc. It is imperative that control compartments, burners and circulating air passageways be kept clean.
 4. **A damper clamp must be installed to provide the minimum permanent vent opening to vent flue products, Refer to installation instructions.**
 5. Never burn solid fuels in a fireplace where a gas log set is installed.
 6. **This appliance must NOT be used with glass doors in the closed position.** A fireplace screen must be in place when the log set is burning. Provisions for adequate combustion air must be provided. Adequate combustion air usually results in all flames curling into the fireplace away from the screen and up the flue.
 8. Keep room area clear and free from combustible materials, gasoline and other flammable vapors and liquids.
 9. Children and adults should be alerted to the hazard of high surface temperature and should stay away to avoid burns or clothing ignition.
 10. Young children should be carefully supervised when they are in the same room with the gas log set in operation.
 11. Do not place clothing or other flammable material near the fireplace when the gas logs are in use.
 12. Do not use this gas log set if any part has been underwater. Immediately call a qualified service technician to inspect the gas logs and replace any part of the control system and any gas control which has been under water.
 13. The gas log set must be isolated from the gas supply piping system by closing its individual manual shutoff valve during any pressure testing of the gas supply piping system at test pressures equal to or less than 1/2 psig (3.5kPa).
 14. Secure gas log set to fireplace.
 15. This log set will burn off the paint on the front grate bar. **NOTE:** See cleaning section for refurbishing.
 16. Inspect the burner before each use of the appliance. The burner must be replaced prior to operation if there is evidence the burner is damaged. Use only burner specified by manufacturer.
- LP-cylinder enclosures, if provided by the consumer must conform to the design parameters as detailed on Page 4.
- Installation of this vented gas log in the Commonwealth of Massachusetts requires the damper be permanently removed or welded in the full open position. In addition, a naturally vented gas log may not be installed in a bedroom or bathroom in the Commonwealth of Massachusetts. Flex line installation must not exceed 36".

MAKE SURE YOU HAVE RECEIVED ALL PARTS:

Check your packing list to verify that all listed parts have been received. You should have the following:

BURNER - GRATE ASSEMBLY 24" & 30"

- Burner and Valve Assembly
- Grate
- Lava Rocks (x 4)
- Extenders with Knob
- Damper Clamp
- Installation /Operating Instructions
- 3/8" Aluminum tube with 3/8" 90° elbow, 1/2" to 3/8" tube fitting
- 4, Mounting Screws
- Regulator (LP Only)

24" or 30" REFRACTORY LOGS

- Individual Logs

Carefully inspect the contents for shipping damage. If any parts are missing or damaged, immediately inform the dealer from whom you purchased the appliance. **Do not attempt to install any part of the appliance unless you have all parts in good condition.**

ITEMS REQUIRED FOR INSTALLATION

Ensure that the following items are available before proceeding with installation:

- External regulator (for propane/L.P.G. only)
- Shutoff valve
- Piping which complies with local codes
- Pipe wrench
- Pipe sealant approved for use with propane/L.P.G. (Resistant to sulfur compounds)
- Drill with masonry bit (for mounting to the floor)

GAS PRESSURES

	Natural	Propane (LP)
Inlet Minimum	4.0" w.c.	10.0" w.c.
Inlet Maximum	10.0" w.c.	13.0" w.c.

GAS SPECIFICATIONS

Model	Fuel	Control	Nominal Btu/hr
VWF24N	Nat.	Manual	90,000
VWF24P	LP	Manual	60,000
VWF30N	Nat.	Manual	90,000
VWF30P	LP	Manual	60,000

NOTE: Actual performance, flame height, Btu/hr will vary with specific installation, gas pressure, shutoff valve position (fully open), valve type, and firebox draft conditions.

ENCLOSURES FOR LP-GAS SUPPLY SYSTEMS

Enclosures for LP-gas supply cylinders shall be ventilated by openings at the level of the cylinder valve and at floor level. The effectiveness of the opening(s) for purposes of ventilation shall be determined with the LP-gas supply cylinder(s) in place. This shall be accomplished by one of the following:

- One side of the enclosure shall be completely open; or
- For an enclosure having four sides, a top and a bottom:
 - At least two ventilation openings at cylinder valve level shall be provided in the side wall, equally sized, spaced at 180 degrees (3.14rad), and unobstructed. Each opening shall have a total free area of not less than 1/2 square inch per pound (3.2 sq. cm/kg) of stored fuel capacity and not less than a total free area of 10 square inches (64.5 sq. cm).
 - Ventilation opening(s) shall be provided at floor level and shall have a total free area of not less than 1/2 square inch per pound (3.2 sq. cm/kg) of stored fuel capacity and not less than a total free area of 10 square inches (64.5 sq. cm). If ventilation openings at floor level are in a side all, there shall be at least two openings. The bottom of the openings shall be at floor level and the upper edge no more than 5 inches (127 mm) above the floor. The openings shall be equally sized, spaced at 180 degrees (3.14 rad) and unobstructed.
 - Every opening shall have minimum dimensions so as to permit the entrance of a 1/8 inch (3.2 mm) diameter rod.

Cylinder valves shall be readily accessible for hand operation. A door on the enclosure to gain access to the cylinder valves is acceptable, provided it is non-locking and can be opened without the use of tools.

There shall be a minimum clearance of 2 inches (51 mm) between the lower surface of the floor of the LP-gas supply cylinder enclosure and the ground.

The design of the appliance shall be such that (1) the LP-gas supply cylinder(s) can be connected, disconnected and the connections inspected and tested outside the cylinder enclosure; and (2) those connections which could be disturbed when installing the cylinder(s) in the enclosure can be leak tested inside the enclosure.

MINIMUM OPENING AREA OF CHIMNEY DAMPER FOR VENTING

WARNING The fireplace and gas logs function as a system. If the fireplace is not drafting properly and spilling into the room (check with a match or a smoke stick), reposition the damper clamp until a positive draft is obtained by opening the damper.

MINIMUM CHIMNEY HEIGHT AND FLUE OPENING

CHIMNEY HEIGHT	FLUE OPENING
6'	64 sq in
8'	64 sq in
10'	64 sq in
15'	51 sq in
20'	51 sq in
30'	51 sq in

MINIMUM HEARTH DIMENSIONS

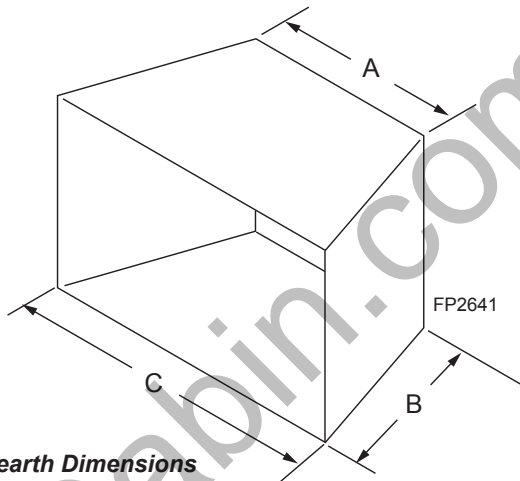

Figure 1 - Minimum Hearth Dimensions

Model	A	B	C
VWFOD24	27" (686 mm)	13½" (343 mm)	30" (762 mm)
VWFOD30	33" (838 mm)	13½" (343 mm)	36" (914 mm)

WARNING Barriers such as the bottom of a glass door frame placed in front of a gas log set can change the air flow characteristics of the fireplace which in turn can cause the unit to overheat and malfunction.

IMPORTANT INFORMATION FOR THE INSTALLATION OF THIS GAS LOG SET PLACEMENT IN A FIREPLACE WITH A RESTRICTIVE BARRIER

The following are guidelines for placing a gas log set in a fireplace that has a restrictive barrier along the bottom front opening of the fireplace. Some examples of barriers are glass/screen door frames and sunken/recessed fireplaces.

Height of Restriction (x)	Minimum Depth of Fireplace/Firebox
No Restriction	13"
1/2" to 1½"	15"
Greater than 1½" to 3"	15"
Greater than 3"	*

*Any barrier greater than 3" placed in front of the gas log set is not recommended by the manufacturer.

NOTE: Non combustible material such as refractory brick may be used to line the floor of the fireplace in order to raise the height of the gas log set in relation to a restrictive barrier. If the unit is raised, the minimum height dimension listed in the homeowner's manual must not be exceeded.

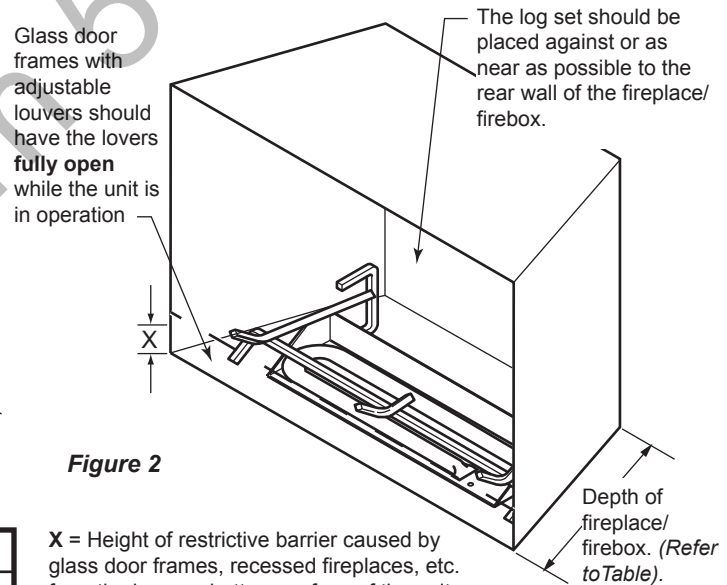

Figure 2

X = Height of restrictive barrier caused by glass door frames, recessed fireplaces, etc. from the base or bottom surface of the unit. (Refer to Table).

CAUTION Do not operate gas log with glass doors in the closed position.

INSTALL AND OPERATE THE APPLIANCE AS DIRECTED IN THIS MANUAL.

DAMPER STOP INSTALLATION

A damper stop must be provided with the unit. The damper stop must be installed as shown in *Figure 3* to prevent full closure of the fireplace damper blade and provide a minimum flue opening, per table on page 5.

Should the clamp not fit, or provide the required permanent opening from the table, have the damper cut to provide a minimum permanent opening or install a permanent stop.

FOR MASSACHUSETTS RESIDENTS ONLY

Installation of this vented gas log set in the Commonwealth of Massachusetts requires the damper be permanently removed or welded in the fully open position. In addition, a naturally vented gas log may not be installed in a bedroom or bathroom in the Commonwealth of Massachusetts.

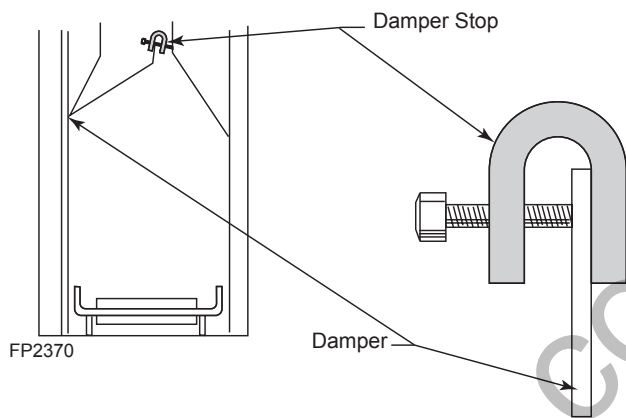

**Figure 3 -
Damper Stop Installation**

BEFORE INSTALLING THE APPLIANCE:

- Turn off gas supply to fireplace or firebox.
- Clean the fireplace floor and chimney before installing the log set. Seal any ash clean-out doors to protect the unit from down drafts.

ASSEMBLY PROCEDURE

1. Place grate/burner assembly into firebox with the front pan facing forward.
2. Drill two (2) 5/32" diameter holes approximately 1½" deep.
3. Anchor the front pan to the floor using the screws provided.

Proper installation of the grate is essential to prevent any movement of the gas logs and controls during operation.

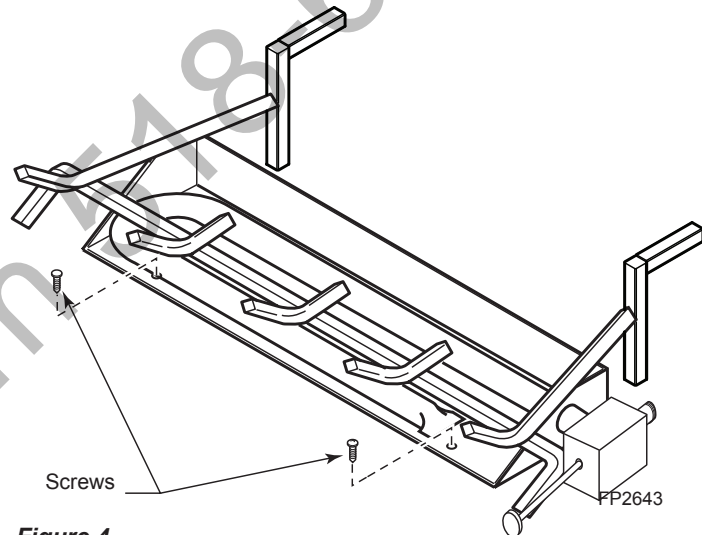

**Figure 4 -
Secure Grate/Burner Assembly into Firebox**

CHECK GAS TYPE

Use proper gas type for the log set you are installing. If you have conflicting gas type, do not install log set. See dealer where you purchased the log set for proper log set for your gas type or conversion kit.

INSTALL GAS PIPING TO LOG SET / BURNER SYSTEM LOCATION

WARNING

A qualified installer or service person must connect appliance to gas supply. Follow all local codes.

CAUTION

For propane/LP units, never connect burner directly to the propane/LP supply. This burner system requires an external regulator (not supplied). Install the external regulator between the burner system and propane/LP supply.

INSTALLATION ITEMS NEEDED

Before installing the burner system, make sure you have the items listed below.

- External regulator (supplied by installer)
- Equipment shutoff valve*
- approved flexible gas line with gas connector (if allowed by local codes — not provided)
- Piping (check local codes)
- Test gauge connection*
- Tee joint
- Sealant (resistant to propane/LP gas)
- Sediment trap (recommended)
- Pipe wrench

* A CSA design-certified equipment shutoff valve with 1/8" NPT tap is an acceptable alternative to test gauge connection. Purchase the CSA design-certified equipment shutoff valve from your dealer.

For propane/LP connections only, the installer must supply an external regulator. The external regulator will reduce incoming gas pressure. You must reduce incoming gas pressure to between 11 and 13 inches of water. If you do not reduce incoming gas pressure, burner system regulator damage could occur. Install external regulator with the vent pointing down as shown in *Figure 7*. Pointing the vent down protects it from freezing rain or sleet.

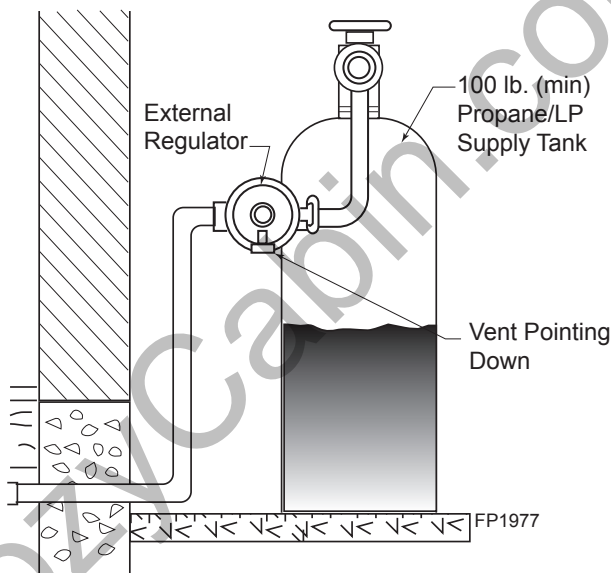

Figure 7 - External Regulator with Vent Pointing Down (Propane/LP Only)

CAUTION

Use only new black iron or steel pipe. Internally tinned copper or copper tubing can be used per National Fuel Code, Section 2.6.3, providing gas meets hydrogen sulfide limits, and where permitted by local codes. Gas piping system must be sized to provide minimum inlet pressure (listed on data plate) at the maximum flow rate (BTU/hr). Undue pressure loss will occur if the pipe is too small.

When using copper or flex connectors use only fittings approved for gas connections. The gas control inlet is 3/8" NPT.

WARNING

Only persons licensed to work with gas piping may make the necessary gas connections to this appliance.

CAUTION

A manual shutoff valve must be installed upstream of the appliance. Union tee and plugged 1/8" NPT pressure tapping point should be installed upstream of the appliance. *Figure 6*

NOTE : The gas line connection may be made using 1/2" rigid tubing or an approved flex connector. Since some municipalities have additional local codes it is always best to consult your local authorities and the current edition of the National Fuel Gas Code ANSI.Z223.1, NFPA54. In Canada CSA-B149 (1 or 2) Installation Code.

A listed manual shutoff valve must be installed upstream of the appliance. Union tee and plugged 1/8" NPT pressure tapping point should be installed upstream of the appliance. *Figure 6*

IMPORTANT: Install main gas valve (equipment shutoff valve) in an accessible location. The main gas valve is for turning on or shutting off the gas to the fireplace.

Check your building codes for any special requirements for locating equipment shutoff valve to fireplaces.

Apply pipe joint sealant lightly to male threads. This will prevent excess sealant from going into pipe. Excess sealant in pipe could result in clogged burner system valves.

CAUTION

Use pipe joint sealant that is resistant to liquid petroleum (LP) gas.

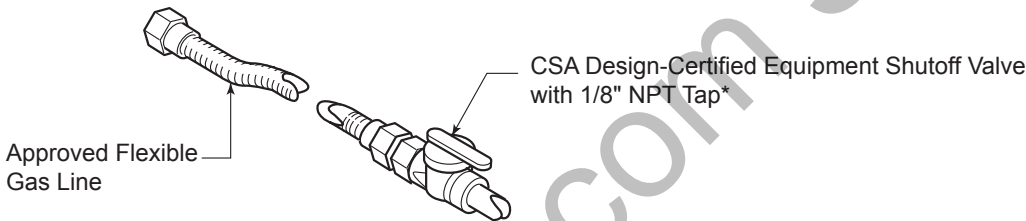

Figure 6 - Gas Connection

Natural Gas
 From Gas Meter
 (4.5" w.c. to 10.5" w.c. Pressure)
Propane/LP
 From External Regulator
 (11" w.c. to 13" w.c. Pressure)

FILLING THE BURNER PAN

Fill the burner pan with lava rock to the bottom of the grate bars and sloped to the front edge of the burner pan. Excess lava rock can spill forward or to the side of the burner pan. Do not overfill the propane model. The lava rock may also be used to cover the front and side areas of the fireplace floor.

VWF24 MASSIVE OAK LOGS

1. Center rear log #1 on grate bars and flush with rear of the grate. *Figure 7*

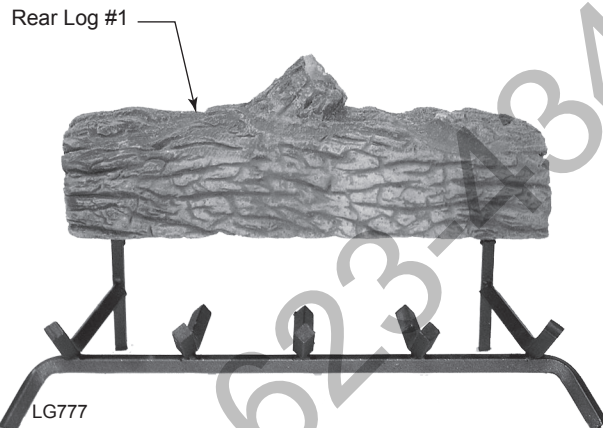

Figure 7 - Center Rear Log (#1) on Grate Bars

2. Place front left log #2 on the front of the grate and to the left. *Figure 8*
3. Place front right log #3 on the front of the grate and to the right. *Figure 8*

NOTE: Allow 2" between the back log and the two front logs.

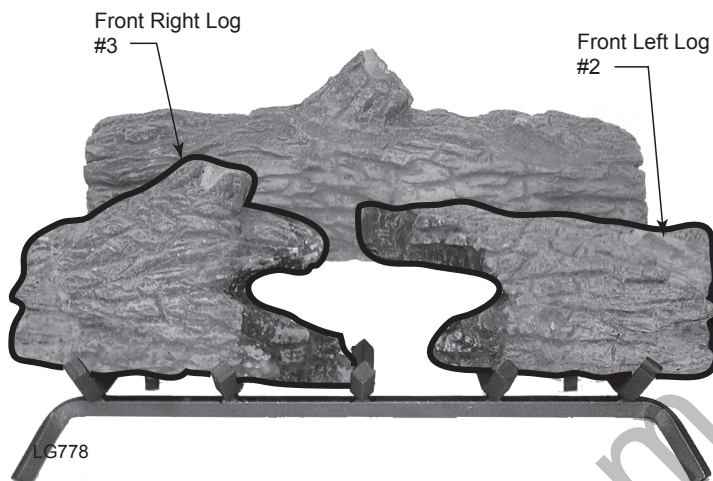

Figure 8 - Place Front Left Log #2 and Right Log #3

4. Install left side middle log #4. *Figure 9*

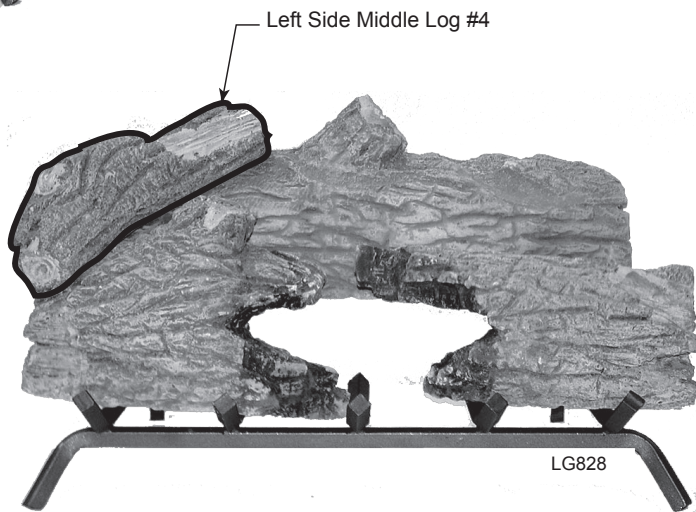
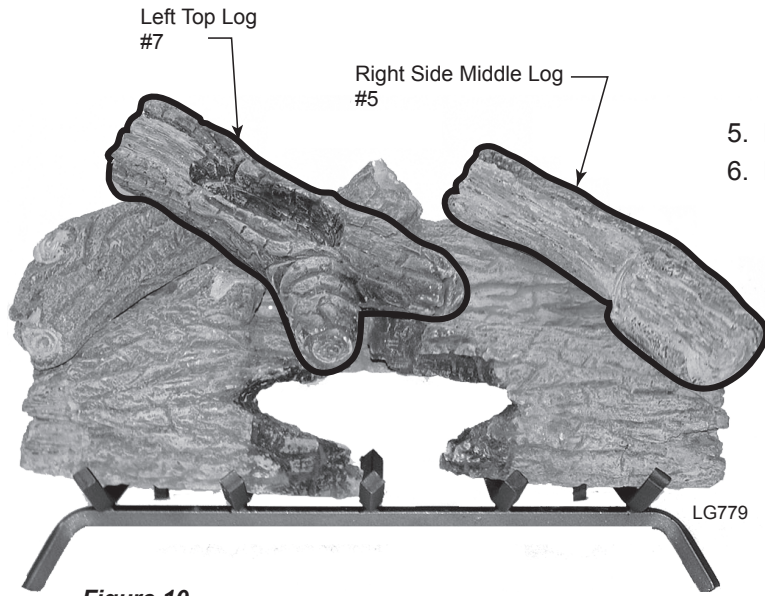

Figure 9 - Place Left Middle Log #4



- 5. Install right side middle log #5. *Figure 10*
- 6. Install left top log #7 as shown. *Figure 10*

**Figure 10 -
Place Right Side Middle Log #5 and Left Top Log #7**

- 7. Install right top log #6 as shown. *Figure 11*

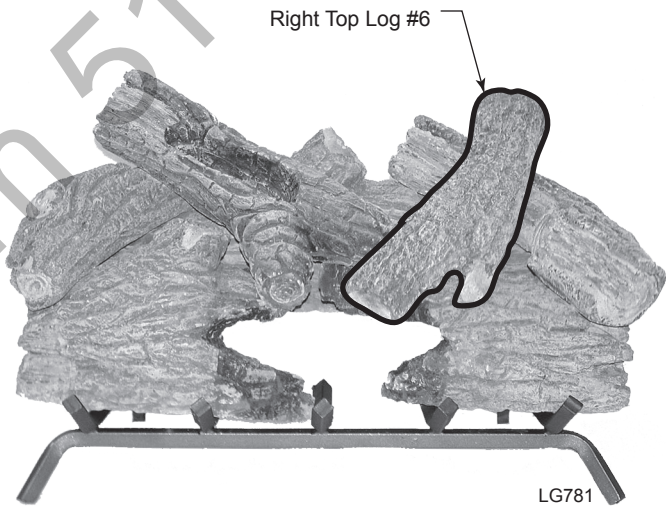

**Figure 11 -
Place Right Top Log #6**

VWF30 MASSIVE OAK LOGS

1. Center rear log #1 on grate bars and flush with rear of the grate. *Figure 12*

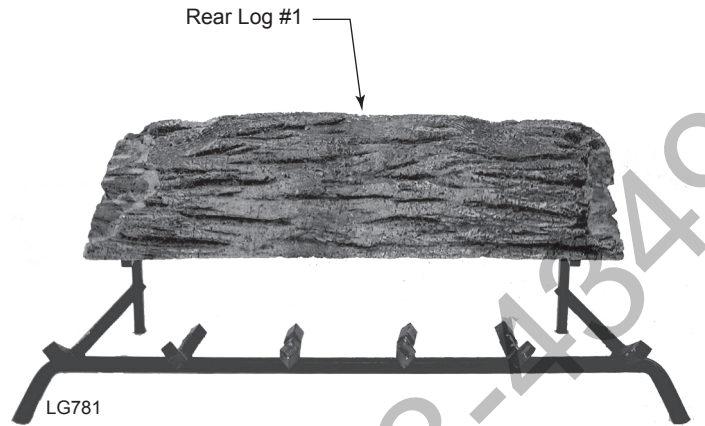

**Figure 12 -
Center Rear Log #1 on Grate Bars**

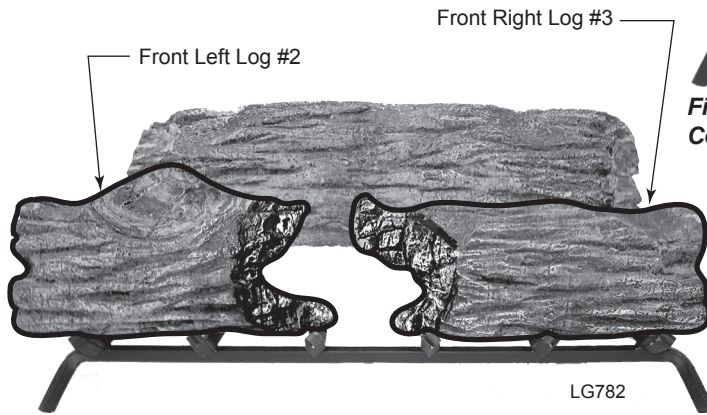
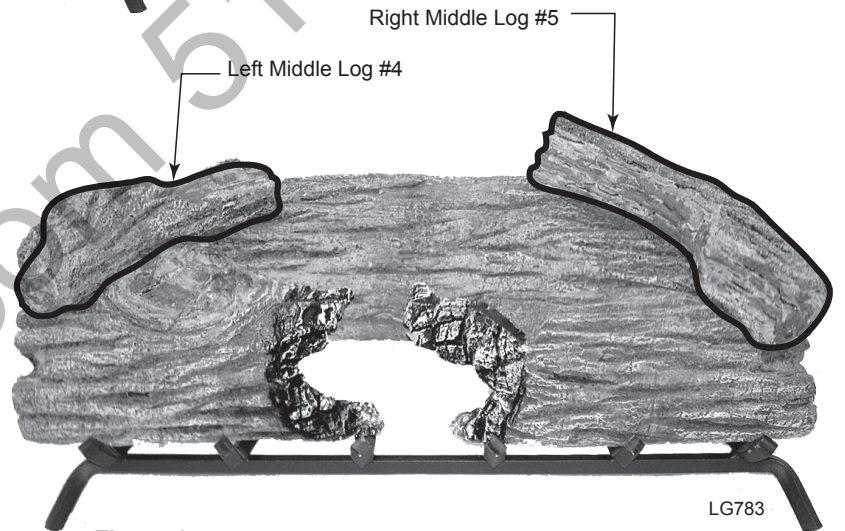

**Figure 13 -
Place Front Left Log #2 and Right Log #3**

2. Place front left log #2 on the front of the grate and to the left. *Figure 13*
3. Place front right log #3 on the front of the grate and to the right. *Figure 13*

NOTE: Allow 2" between the back log and the two front logs.

4. Install left middle log #4 as shown. *Figure 14*
5. Install right middle log #5 as shown. *Figure 14*



**Figure 14 -
Place Right Middle Log (#5)**

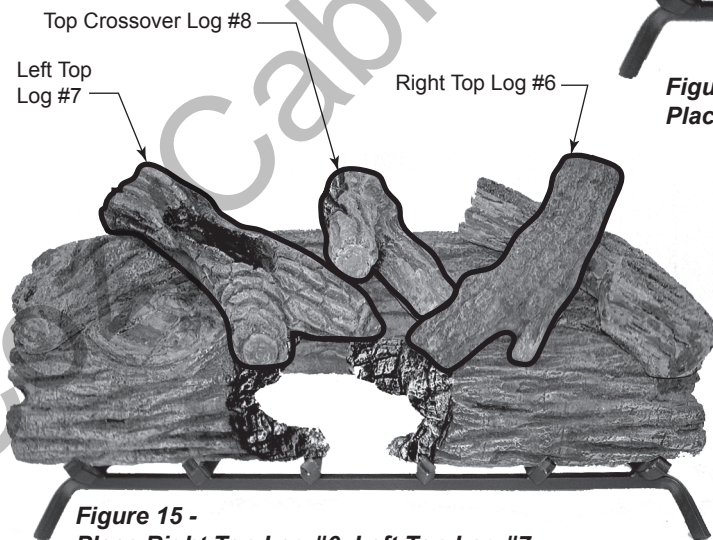

**Figure 15 -
Place Right Top Log #6, Left Top Log #7
and Top Crossover Log (#8)**

6. Install right top log #6 as shown. *Figure 15*
7. Install left top log #7 as shown. *Figure 15*
8. Install top crossover log #8 as shown. *Figure 15*

VWF24 AMERICAN OAK LOGS

NOTE: Each log has an identifying number embossed on bottom surface.

1. Place Back Log #2 on grate bars on back of grate. *Figure 16*

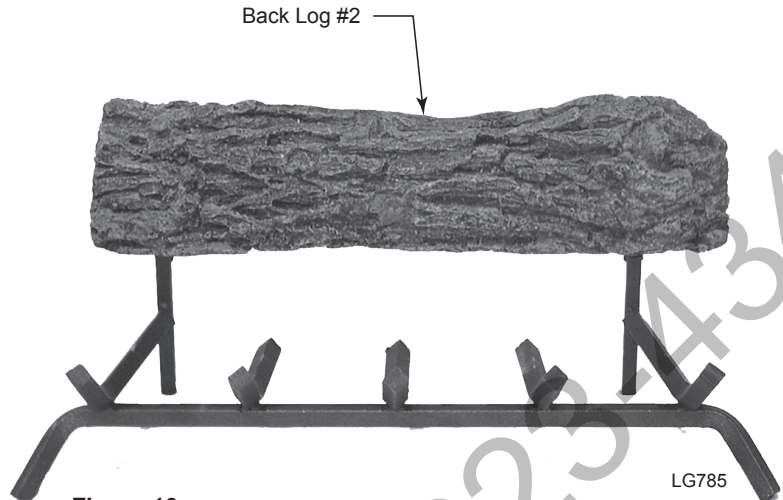

Figure 16 - Place Back Log #2 on Grate Bars at Back of Grate

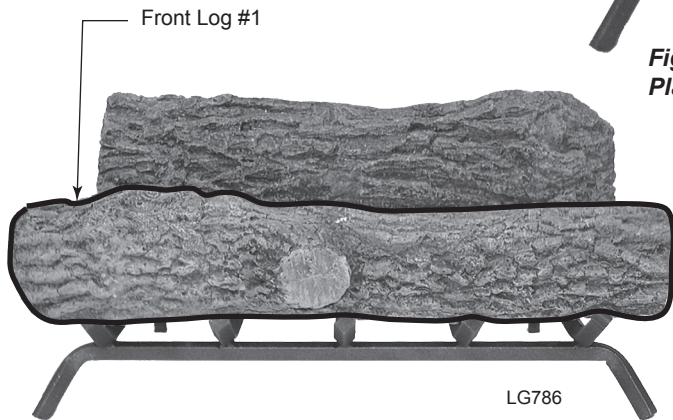

Figure 17 - Place Front Log #1 on Front of Grate

2. Place Front Log #1 on front of grate. *Figure 17*
NOTE: Allow 2" between back and front logs.

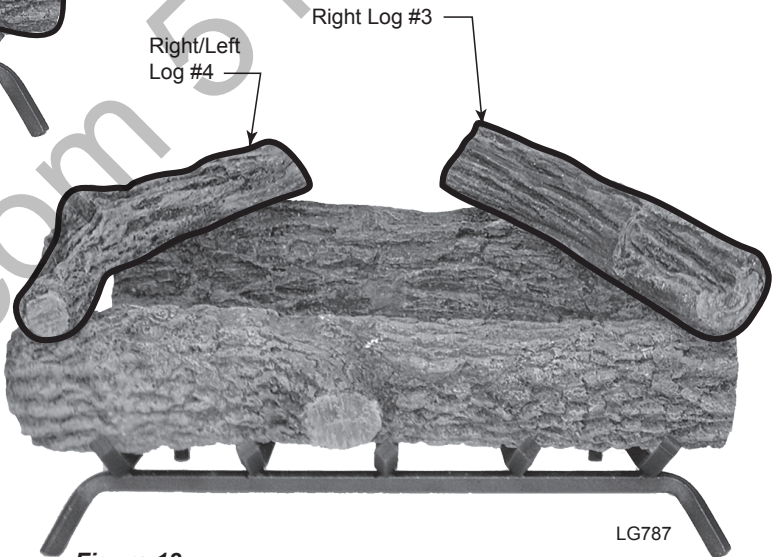

Figure 18 - Place Right Log #3 and Right/Left Log #4

3. Place Right Log #3 on top right of Log #1 and Log #2. *Figure 18*
4. Place Right/Left Log #4 on top left of Log #1 and Log #2. *Figure 18*

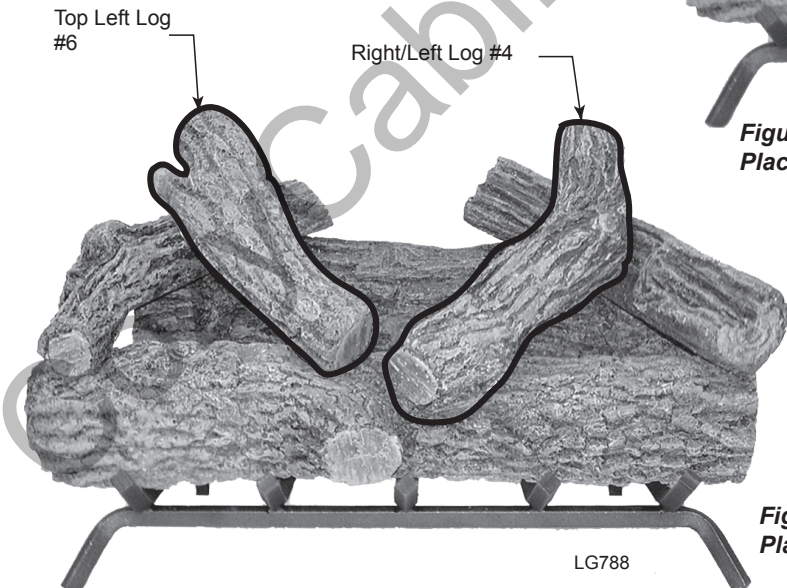

Figure 19 - Place Right/Left Log #4 and Top Left Log #6

5. Rest Right/Left Log #4 on Log #3 and Log #1. *Figure 19*
6. Rest Top Left Log #6 on Log #4 and Log #1. *Figure 19*

VWF30 AMERICAN OAK LOGS

NOTE: Each log has an identifying number embossed on bottom surface.

1. Place Back Log #2 on grate bars on back of grate. *Figure 20*

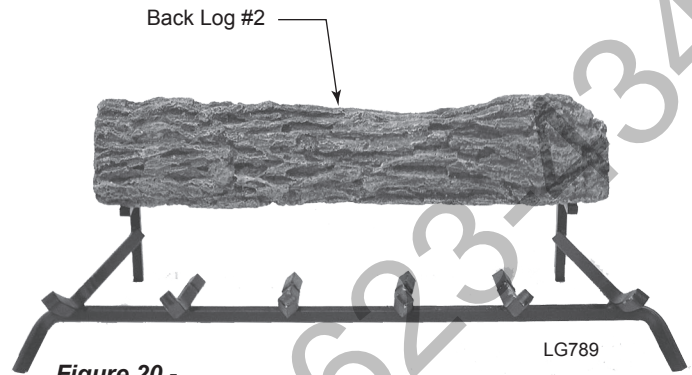

Figure 20 - Place Back Log #2 on Grate Bars at Back of Grate.

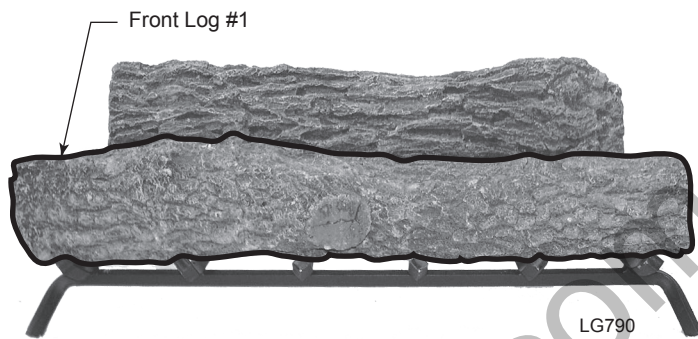

Figure 21 - Place Front Log #2 on Front Grate

2. Place Front Log #1 on front of grate. *Figure 21*
- NOTE:** Allow 2" between back and front logs.

3. Place Right/Left Middle Log #4 on top right of Log #1 and Log #2. *Figure 22*
4. Place Right/Left Middle Log #4 on top left of Log #1 and Log #2. *Figure 22*

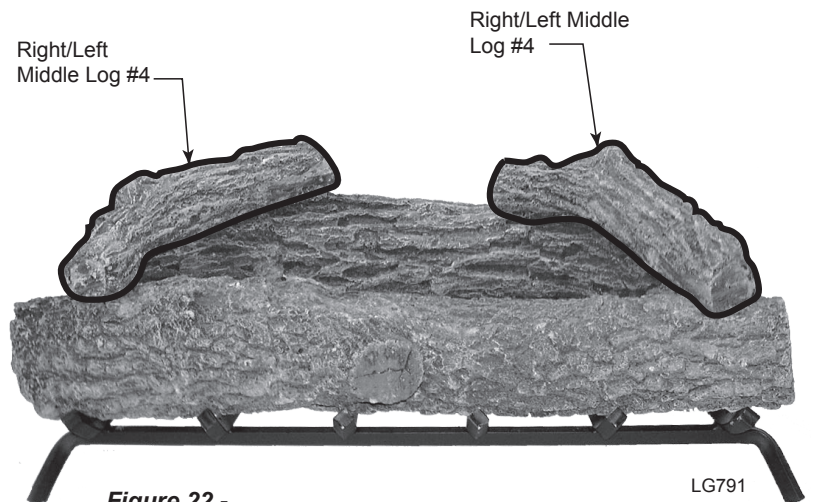

Figure 22 - Place Two (2) Right/Left Middle Logs #4

VWF30 AMERICAN OAK LOGS (continued)

5. Place Top Right/Left Log #5 on Log #4 and Log #1. *Figure 23*
6. Place Top Right/Left Log #5 on Log 4 and Log #1. *Figure 23*

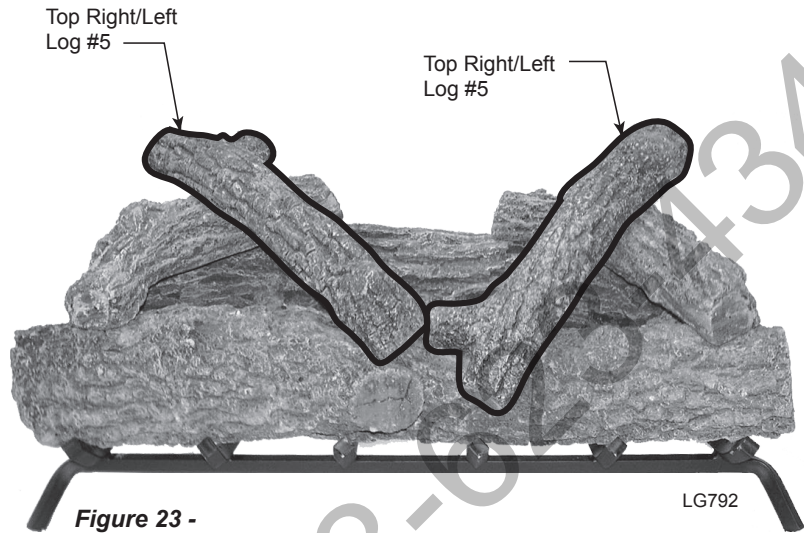

Figure 23 - Place Two (2) Top Right/Left Logs #5

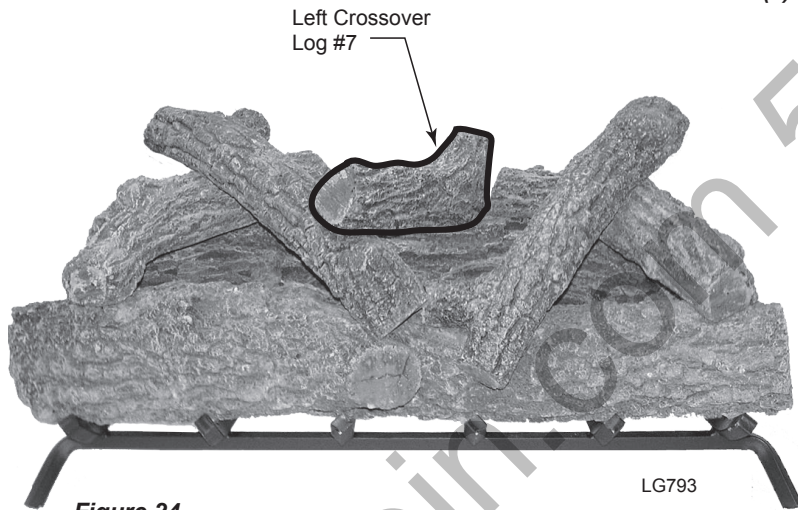

Figure 24 - Place Left Crossover Log #7

7. Place Left Crossover Log #7 on Log #2 and Log #5. *Figure 24*

8. Place Right Crossover Log #8 on Log #5 and Log #7. *Figure 25*

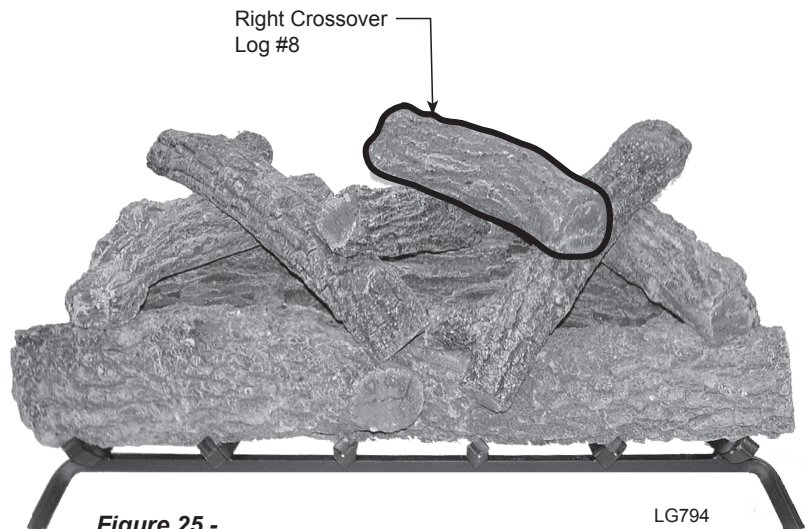
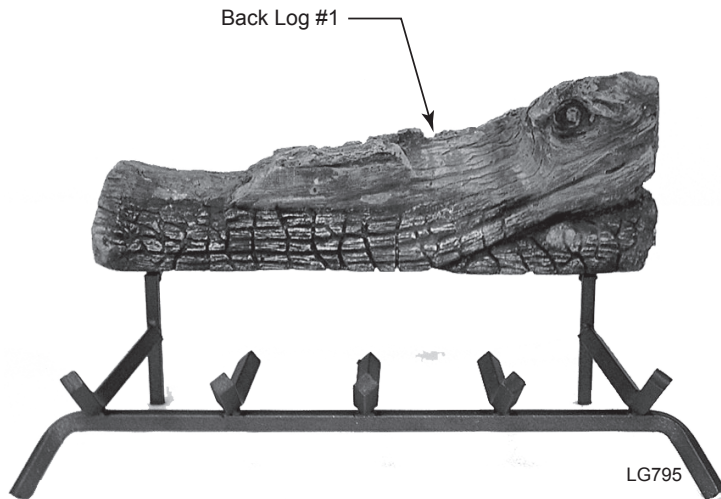

Figure 25 - Place Right Crossover Log #8

MODELS VWF30/24 SPLIT RIVER OAK



**Figure 26 -
Place Rear Log #1 on Back of Grate**

1. Place Back Log #1 on back of grate. *Figure 26*

2. Place Bottom Left Log #2 in front of back log on left arm of grate. Rest end of bottom left log between second and third prong of grate. *Figure 27*
3. Place end of Bottom Right Log #3 on cutout of back log #1. Rest other end of right bottom log to the outside of right grate prong on floor. *Figure 27*

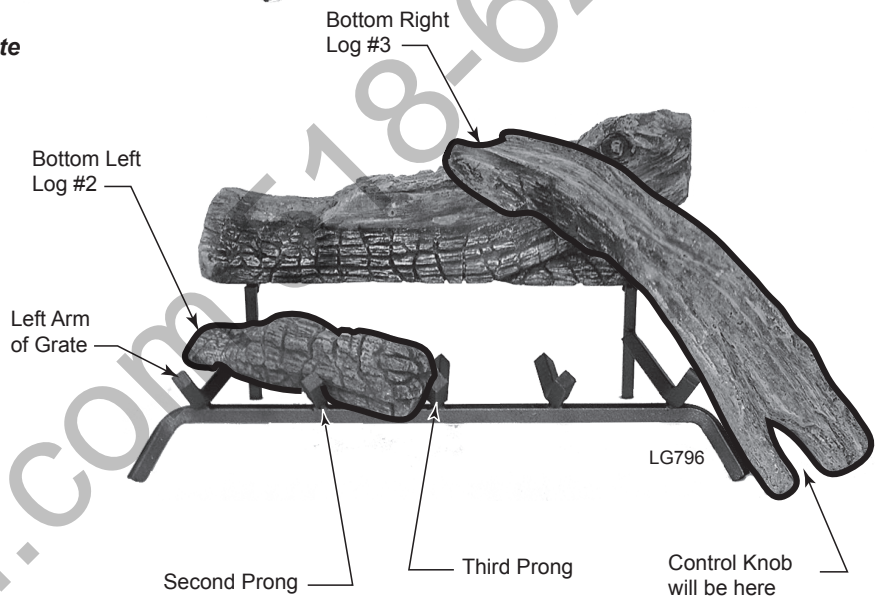

**Figure 27 -
Place Bottom Left Log #2 and Bottom Right (#3) Log on Grate**

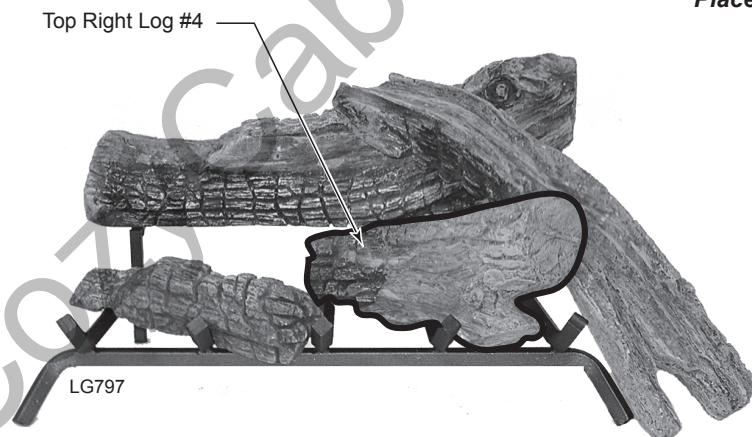
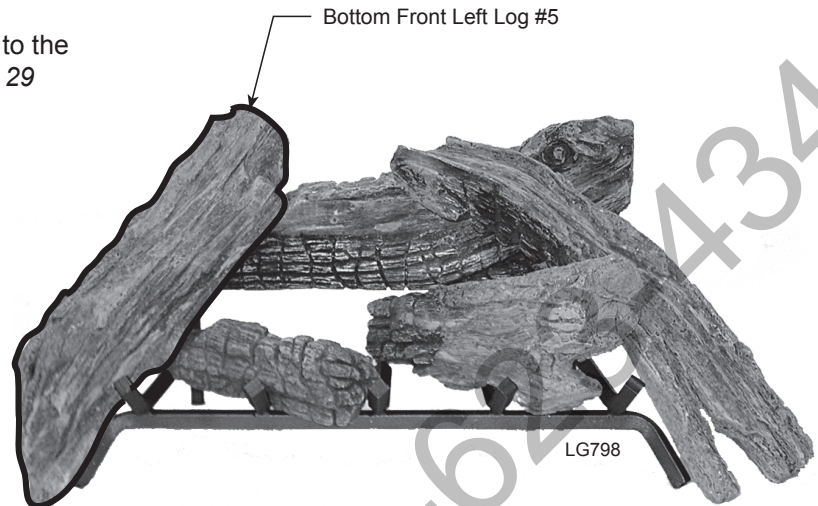

**Figure 28 -
Place Top Right Log #4 on Bottom Left Log**

4. Place right end of Top Right Log #4 on the second and third grate prong. *Figure 28*

MODELS VWF30/24 SPLIT RIVER OAK (continued)

5. Place Bottom Left Log #5 on back log #1 and to the outside of the left grate prong on floor. *Figure 29*



**Figure 29 -
Place Bottom Front Left Log #5**

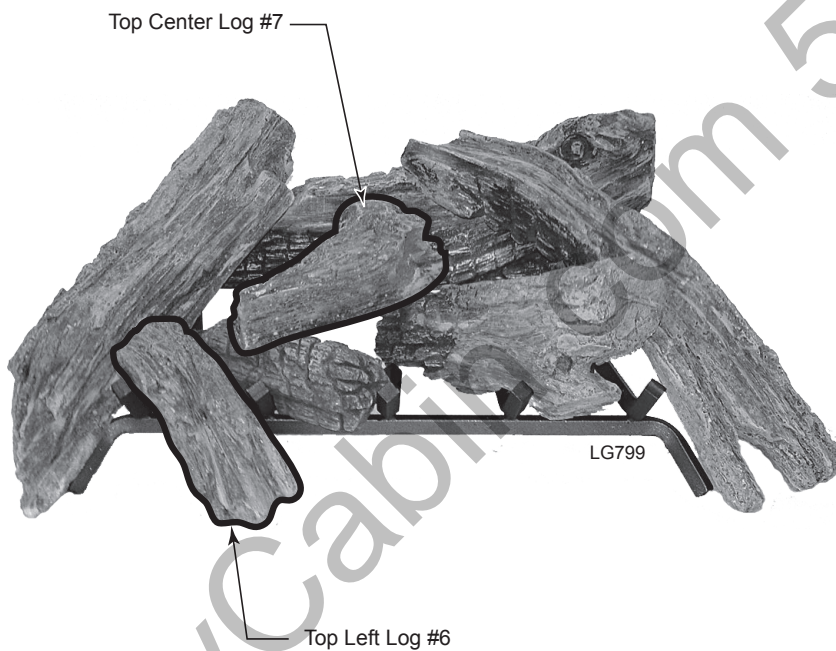

6. Place end of Top Left Log #6 on bottom left log. Rest the other end between the first and second grate prongs. *Figure 30*
7. Place Top Center Log #7 on bottom left log #2 and top right log #4. *Figure 30*

**Figure 30 -
Place Bottom Left Log #6 and Center Top Log #7**

MODELS VWF36/30 SPLIT RIVER OAK

1. Place Back Log #1 on back of grate.
Figure 31

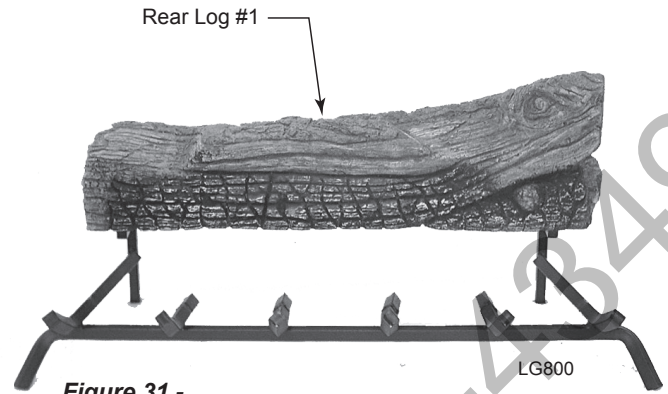

Figure 31 - Place Rear Log #1 on Back of Grate

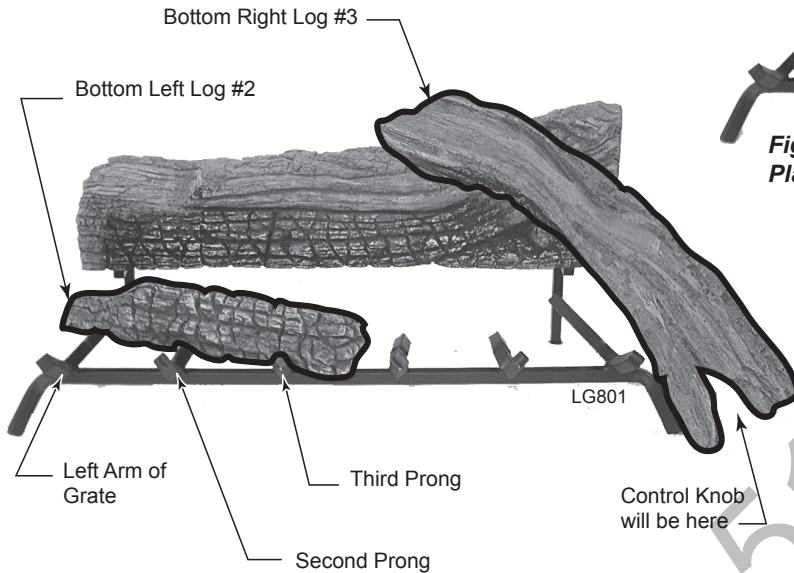

Figure 32 - Place Bottom Left Log #2 and Bottom Right #3 Log on Grate

2. Place Bottom Left Log #2 in front of back log on left arm of grate. Place end of bottom left log between third and fourth prong of grate.
Figure 32
3. Place end of Bottom Right Log #3 on cutout of back log #1. Place other end of right bottom log to the outside of right grate prong on floor.
Figure 32

4. Place right end of Top Right Log #4 on the second and third grate prongs.
Figure 33
5. Place Bottom Left Log #5 on back log #1 and to the outside of the left grate prong.
Figure 33

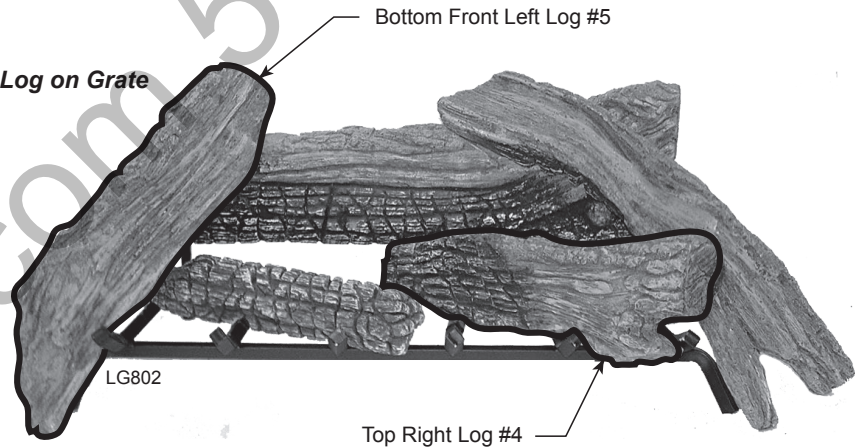

Figure 33 - Place Top Right Log and Bottom Front Left Log #5

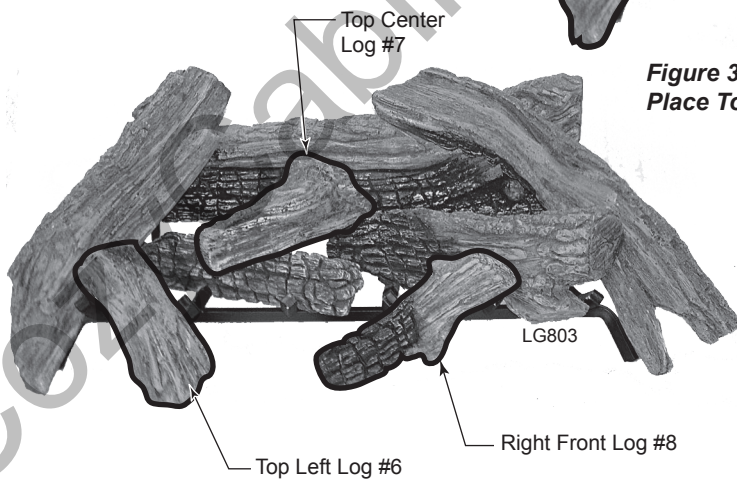

Figure 34 - Place Top Left Log #6, Top Center Log #7 and Front Right Log #8

6. Place end of Top Left Log #6 on bottom left log. Place the other end between the first and second grate prongs.
Figure 34
7. Place Top Center Log #7 on bottom left log #2 and top right log #4.
Figure 34
8. Place Right Front Log #8 on top right log #4 and front of burner pan.
Figure 34

MODELS VWF24 SPLIT PINE

1. Place Left Front Log #1a on front left of grate. *Figure 35*
2. Place Right Front Log #1b on front right of the grate. *Figure 35*

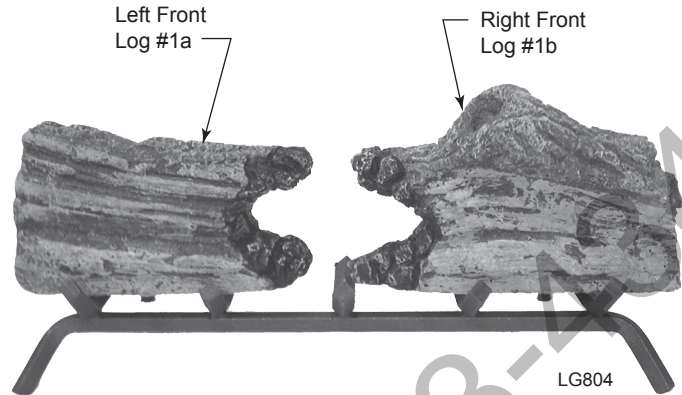

Figure 35 - Place Left Front Log #1a and Right Front Log #1b

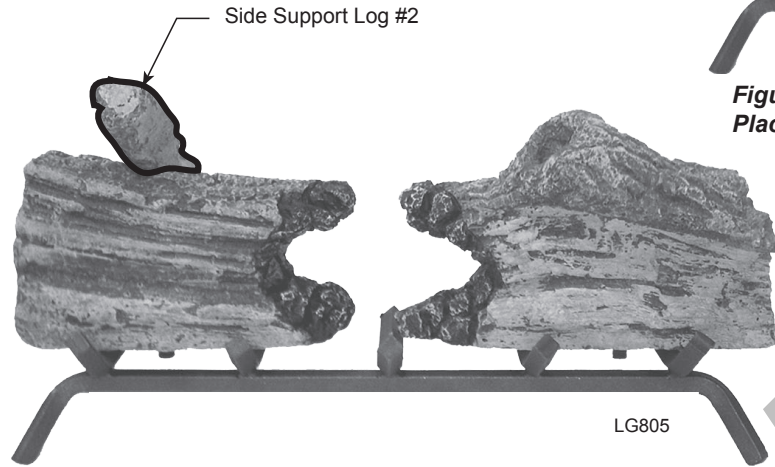

Figure 36 - Place Side Support Log #2 on Top Left of Log #1a

3. Place front end of Side Support Log #2 on top left of Log #1a. Rest other end of Log #2 on rear grate bar. *Figure 36*

4. Fit cutout in the bottom left of Rear Log #3 over the back end of Log #2. Rest right end of Log #3 on rear grate bar. *Figure 37*

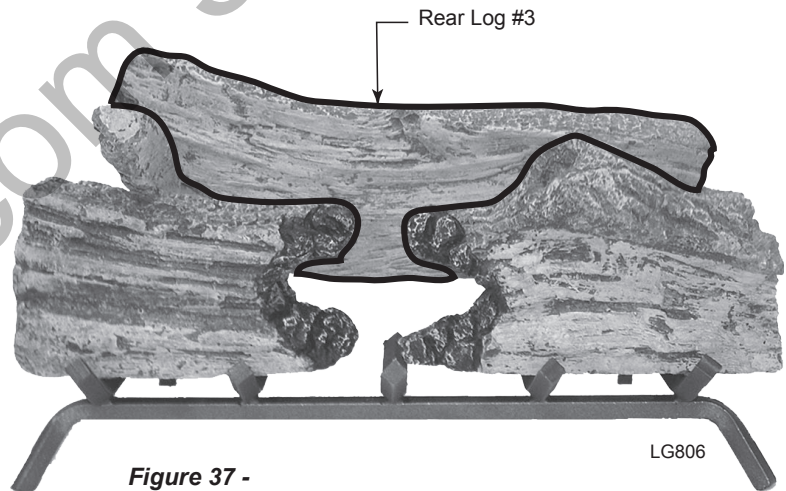

Figure 37 - Place Rear Log #3

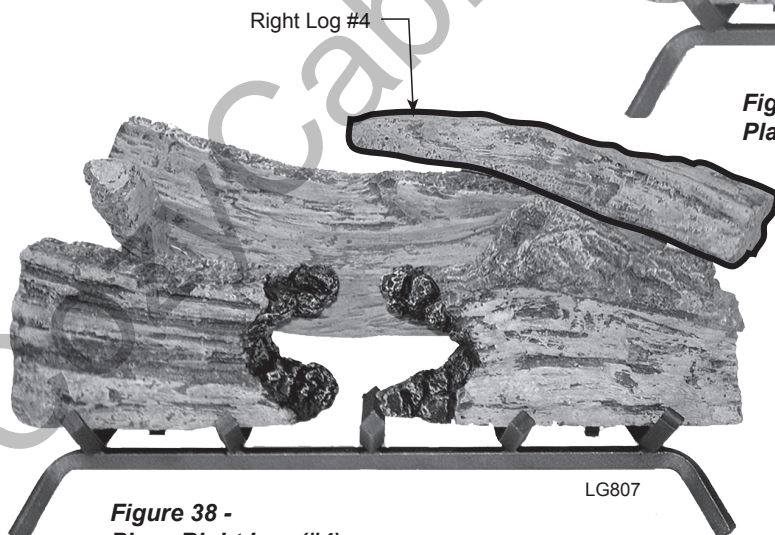
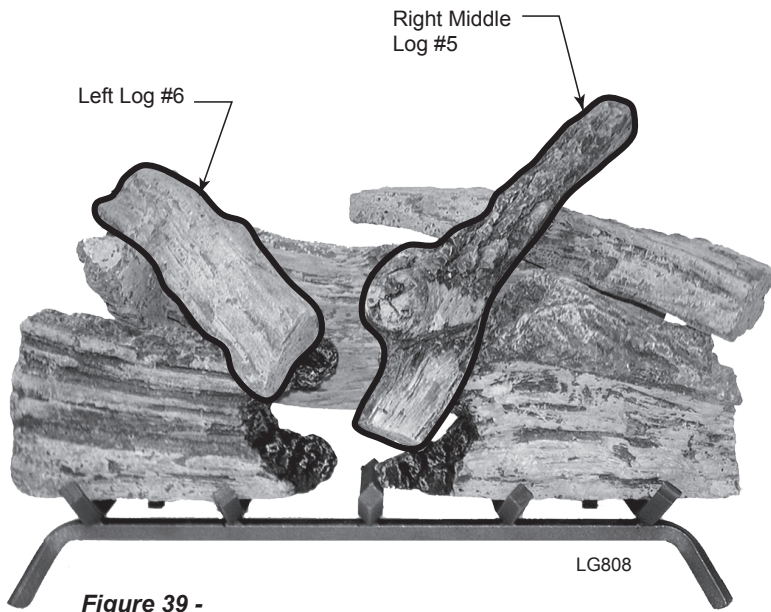

Figure 38 - Place Right Log (#4)

5. Place front end of Right Log #4 on right top of Log #1b. The back end of Log #4 rests to right hump on Log #3. *Figure 38*



**Figure 39 -
Place Right Middle Log #5 and Left Log #6**

6. Place front of Right Middle Log #5 on top right of Log #1ab. Rest back end of Log #5 on top right of Log #4. *Figure 39*
7. Place front of Left Log #6 just left of the middle of Log #1a and back end of Log #6 just left of middle of Log #3. *Figure 39*

8. Lay Top Center Log #7 across log #3 with front end resting on Log #5. *Figure 40*

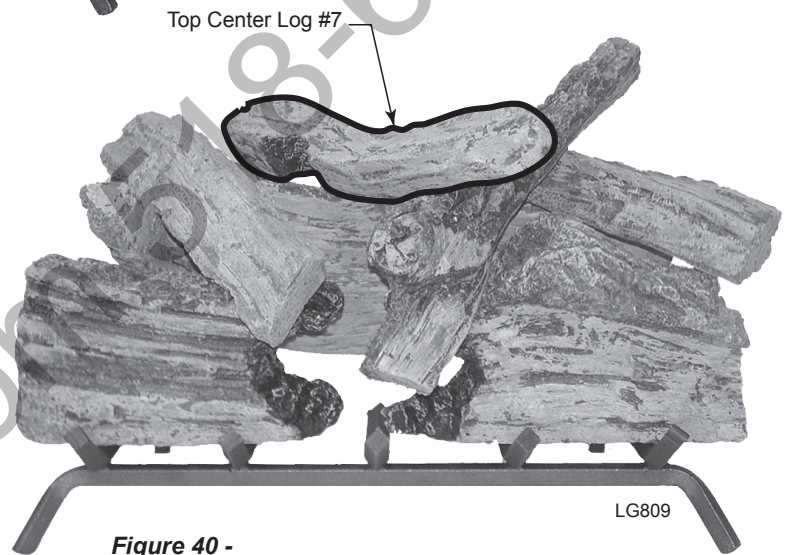

**Figure 40 -
Place Top Left Log #8**

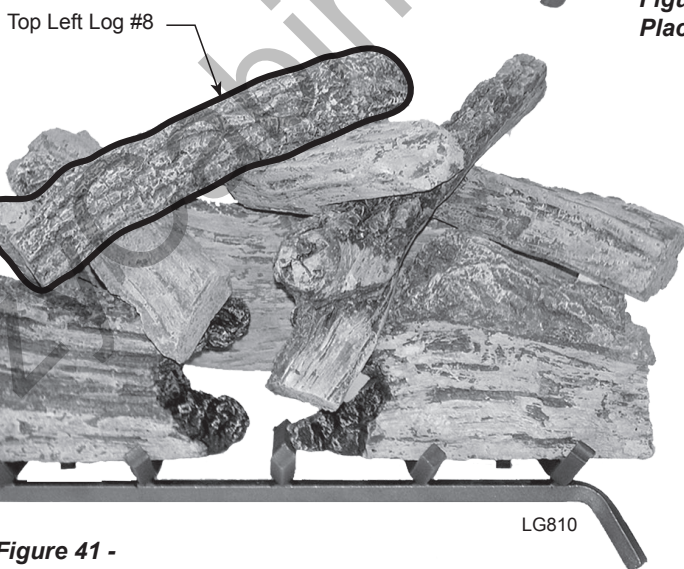

**Figure 41 -
Place Top Center Log #7**

9. Place front end of Top Left Log #8 on Log #7. Let back end of Log #8 rest on Log #6. *Figure 41*

MODELS VWF30 SPLIT PINE

1. Place Left Front Log #1a on front left of grate. *Figure 42*
2. Place Right Front Log #1b on front right of the grate. *Figure 42*

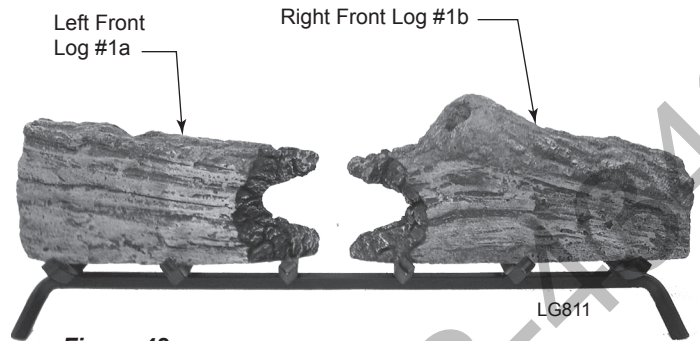

Figure 42 - Place Right Front Log #1b on Grate



Figure 43 - Place Side Support Log #2 on Top Left of Log #1a

3. Place front end of Side Support Log #2 on top left of Log #1a. Place other end of Log #2 on rear grate bar. *Figure 43*

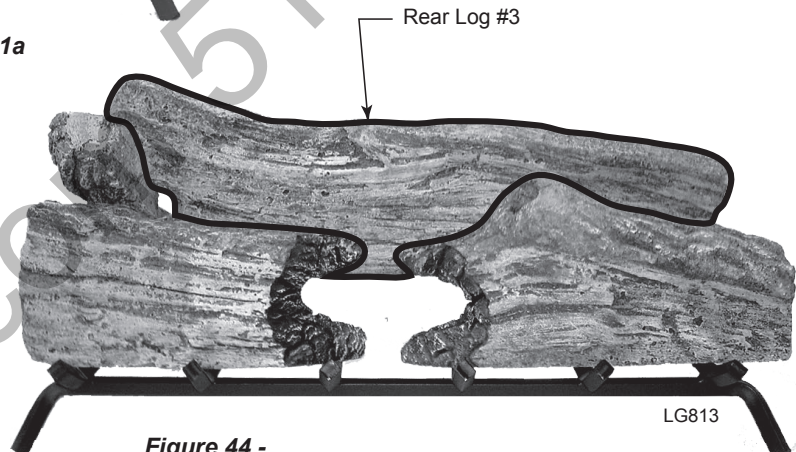

Figure 44 - Place Rear Log #3

4. Fit cutout in the bottom left of Rear Log #3 over the back end of log #2. Place right end of Log #3 on rear grate bar. *Figure 44*

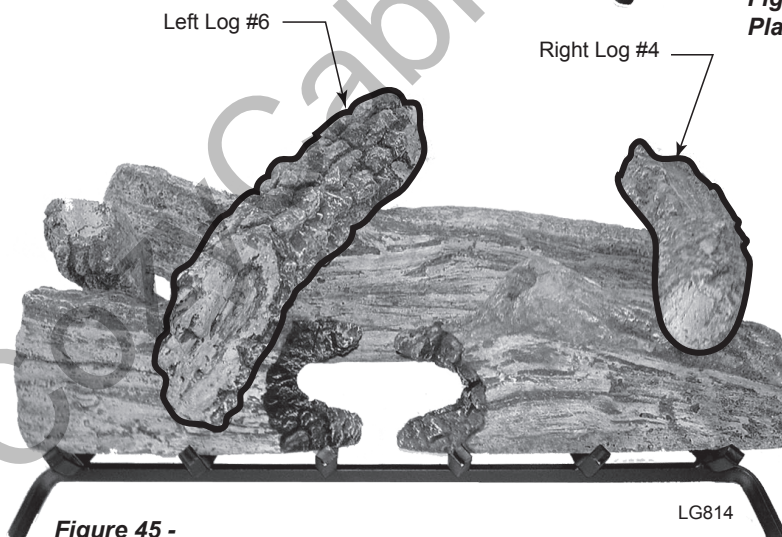
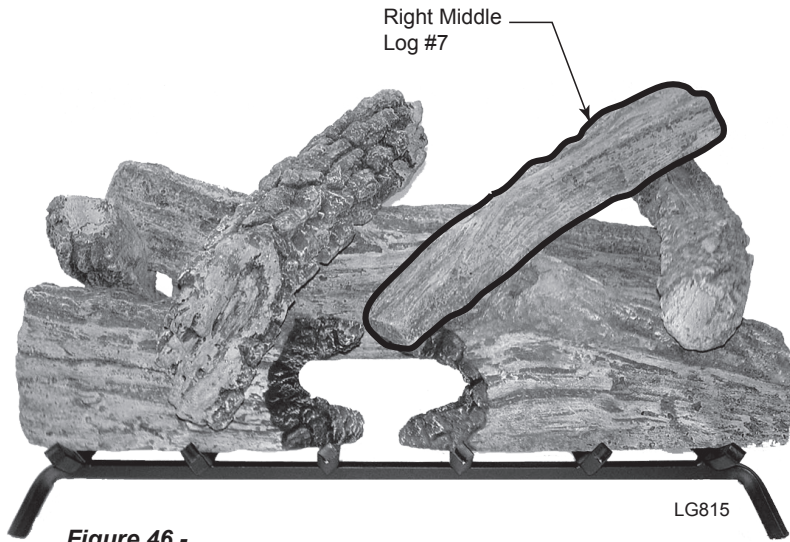

Figure 45 - Place Right Log #4 and Left Log #6

5. Place front end of Right Log #4 on right top of Log #1a. The back end of Log #4 rests to right hump on Log #3. *Figure 45*
6. Place front of Left Log #6 just left of the middle of Log #1a and back end of Log #6 just left of middle of Log #3. *Figure 45*



**Figure 46 -
Place Right Middle Log #7**

7. Place front of Right Middle Log #7 on top right of Log #1b. Place back end of Log #5 on top right of Log #4. *Figure 46*

- 8. Place Top Center Log #5 across log #7 with front end on Log #1b. *Figure 47*
- 9. Place front end of Top Left Log #8 on Log #6. Let back end of Log #8 rest on Log #3. *Figure 47*

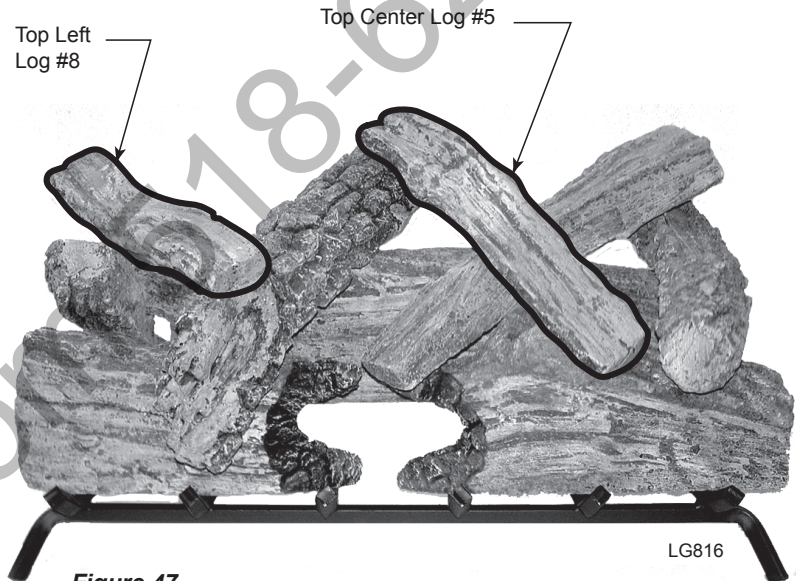

**Figure 47 -
Place Top Center Log #5 and Top Left Log #8**

10. Place front of Top Top Left Log #9 on Log #8 and back of Log #9 on left end of Log #3. *Figure 48*

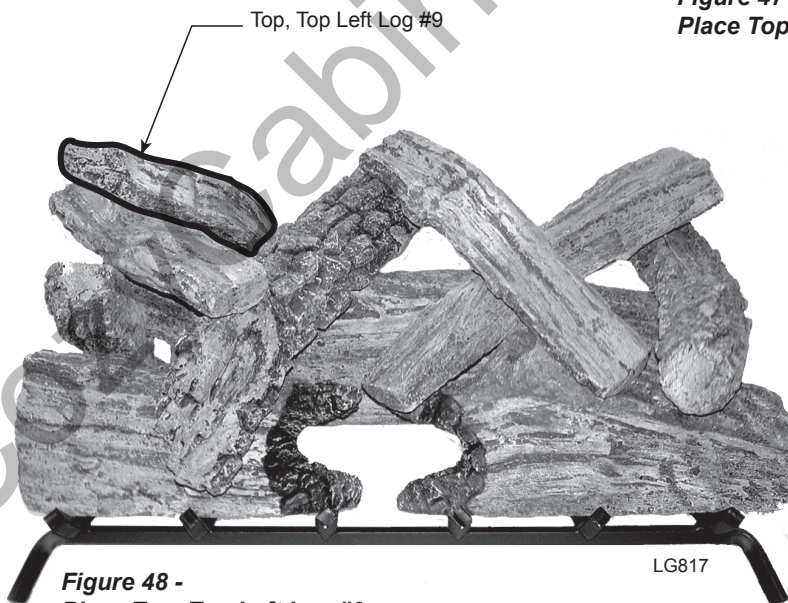

**Figure 48 -
Place Top, Top Left Log #9**

MODEL VWF30/24WP WEATHERED PINE LOG

1. Place Rear Log #1 on back of grate. Left side should fit on grate in front of rear stand. Right side goes on the rear stand of grate. *Figure 49*

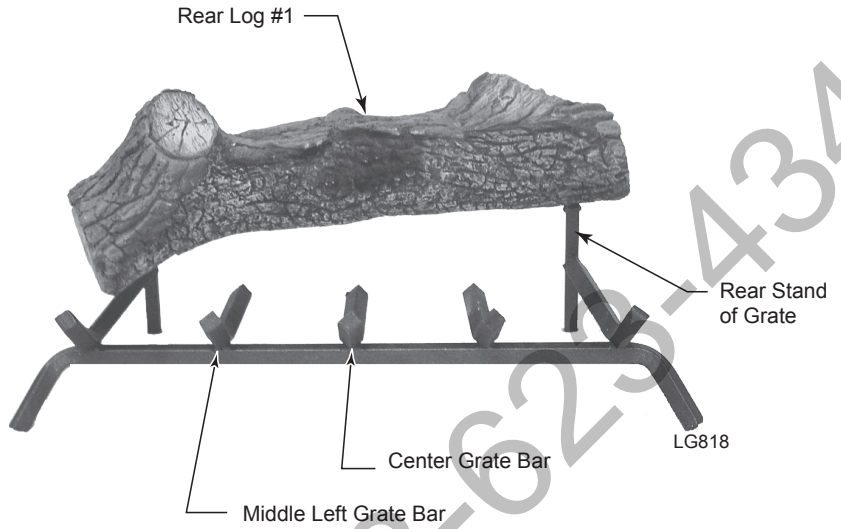

**Figure 49 -
Place Rear Log #1 on Back Grate**

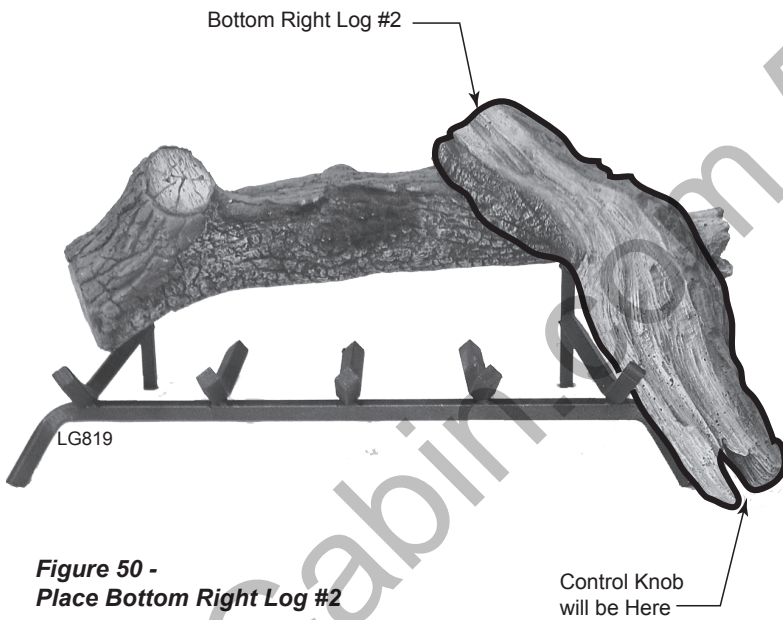

**Figure 50 -
Place Bottom Right Log #2**

2. Place Bottom Right Log #2 along outside of grate. Rest end on Rear Log #1. Control knob will stick through bottom notch of log. *Figure 50*

3. Place Top Right Log #4 on Bottom Right Log #2 resting on grate. *Figure 51*
4. Place Bottom Left Log #3 on grate. The "V" of the log should straddle the end grate bar. *Figure 51*

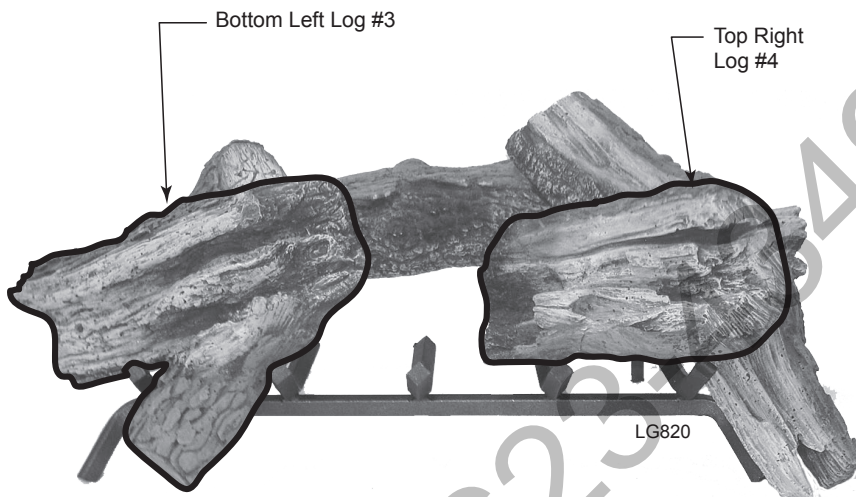

Figure 51 - Place Bottom Left Log #3 and Top Right Log #4

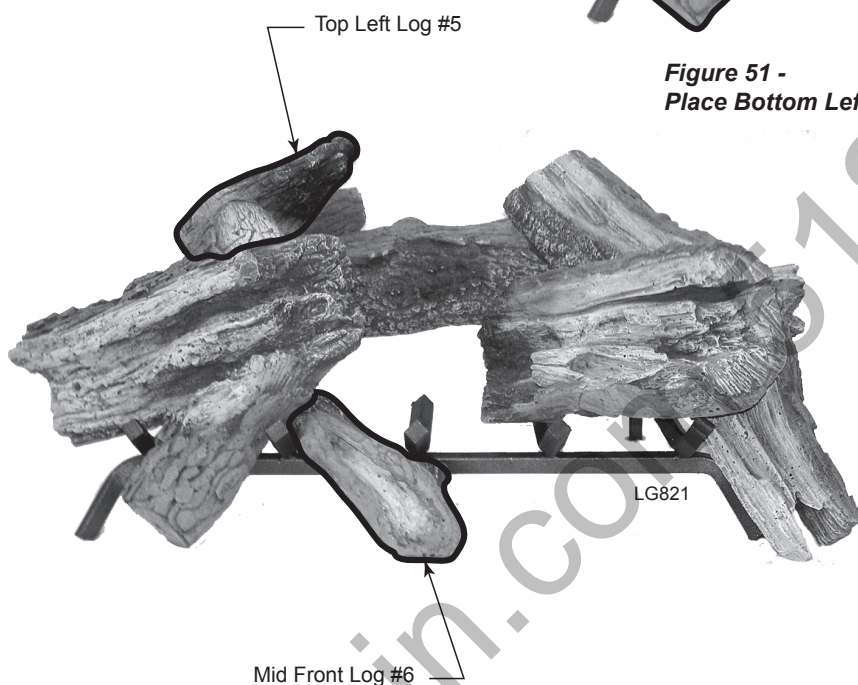

Figure 52 - Place Top Left Log #5 and Mid Front Log #6

5. Place Top Left Log #5 behind Rear Log #1 on the notch on rear left of grate stand. *Figure 52*
6. Place Mid Front Log #6 on grate between center and middle left grate bars. Fit notch on back of log on the cross grate bar. *Figure 52*

7. Place wide end of Top Center Log #7 on Rear Log #1. Rest narrow end of Top Center Log #7 to the left of center grate bar barely touching the Mid Log #6. *Figure 53*

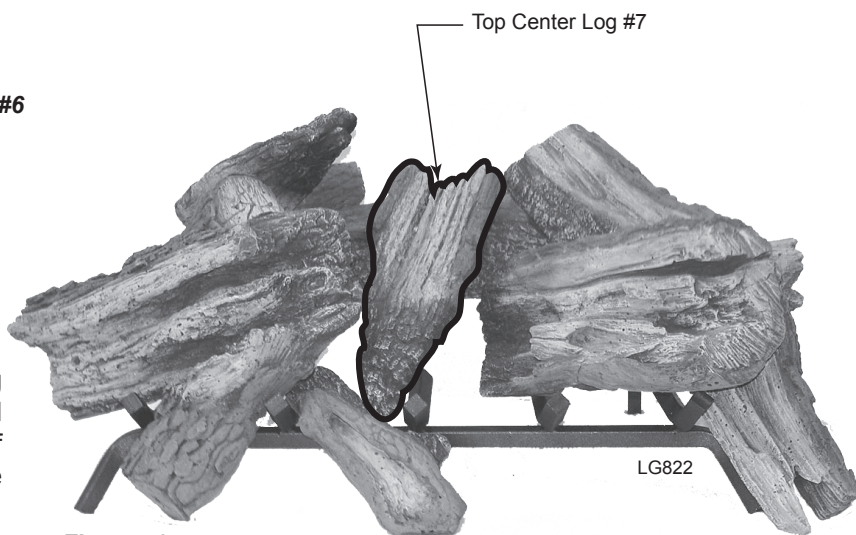

Figure 53 - Place Top Center Log #7

MODEL VWF36/30WP WEATHERED PINE LOG

1. Place Rear Log #1 on back of grate. Left side should fit on grate in front of rear stand. Right side goes on the rear stand of grate. *Figure 54*

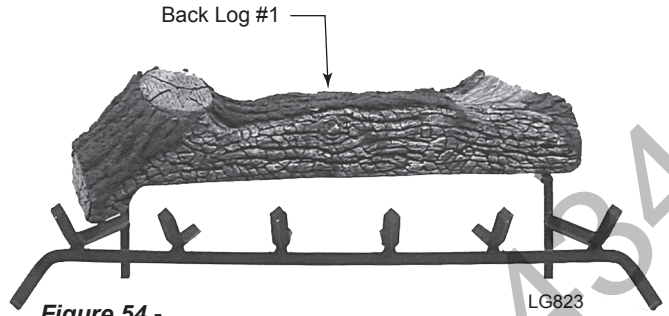

Figure 54 - Place Rear Log #1 on Back Grate

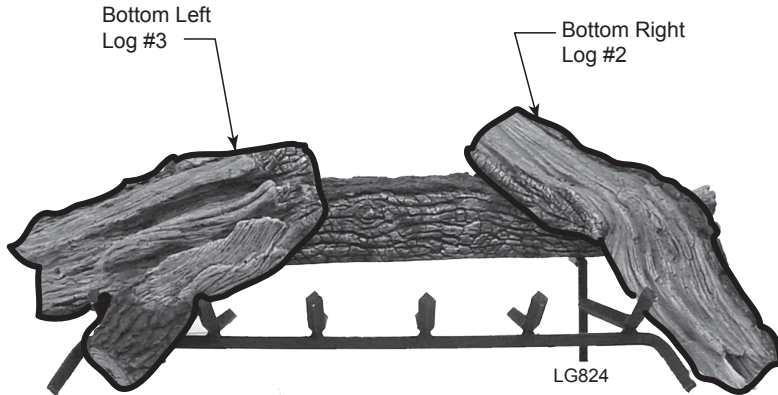

Figure 55 - Place Bottom Right Log #2 and Bottom Left Log #3

2. Place Bottom Right Log #2 along outside of grate. Rest end on Rear Log #1. Control knob will stick through bottom notch of log. *Figure 55*
3. Place Bottom Left Log #3 on grate. The "V" of the log should straddle the end grate bar. *Figure 55*

4. Place Top Right Log #4 on Bottom Right Log #2 resting on grate. *Figure 56*
5. Place Top Left Log #5 behind Rear Log #1 on the notch on rear left of grate stand. *Figure 56*

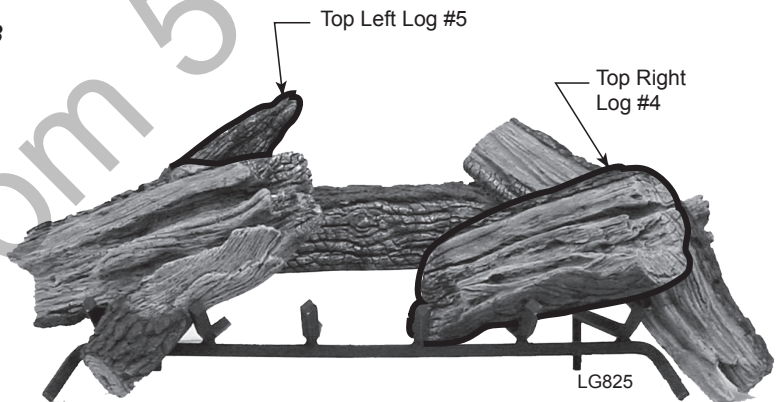

Figure 56 - Place Top Right Log #4 and Top Left Log #5

6. Place Mid Front Log #6 on grate between center and middle left grate bars. Fit notch on back of log on the cross grate bar. *Figure 57*
7. Place wide end of Top Center Log #7 on Rear Log #1. Rest narrow end of Top Center Log #7 to the left of center grate bar barely touching the Mid Log #6. *Figure 57*

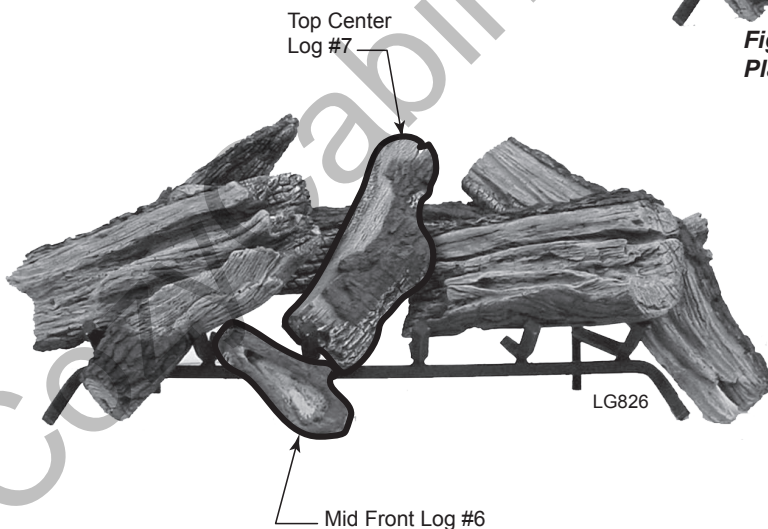

Figure 57 - Place Mid Front Log #6 and Top Center Log #7

SAFETY INSTRUCTION FOR MATCH LIGHT MANUAL CONTROL

FOR YOUR SAFETY READ BEFORE LIGHTING

- A. BEFORE OPERATING smell all around the appliance area for gas. Be sure to smell next to the floor because some gas is heavier than air and will settle on the floor.



WARNING

If you do not follow these instructions exactly, a fire or explosion may result causing property damage, personal injury or loss of life.

WHAT TO DO IF YOU SMELL GAS:

- Do not attempt to light any appliance.
 - Do not touch any electric switch; do not use any phone in your building.
 - Immediately call your gas supplier from a neighbor's phone. Follow the gas supplier's instructions.
 - If you cannot reach your gas supplier, call the fire department.
- B. Use only your hand to turn the gas control knob. Never use tools. If the knob will not turn by hand, don't try to repair it. Call a qualified service technician. Force or attempted repair may result in a fire or explosion.
- C. Do not use this appliance if any part of it has been under water. Immediately call a qualified service technician to inspect the appliance and to replace any part of the control system and any gas control that has been under water.

MANUAL MATCH LIGHT CONTROL LIGHTING INSTRUCTIONS

1. **STOP!** Read the safety information label.
2. Make sure the manual shutoff valve is fully open.
3. Turn gas control knob slightly clockwise  to "OFF."
4. Wait five (5) minutes to clear out any gas. Then smell for gas, including near the floor. If you smell gas, STOP! Follow "B" in the safety information label. If you don't smell gas, go to next step.
5. Light a match and lay it on top of the burner pan lava rock about 3" from end of supply side of burner.
6. From "OFF" position, turn gas control knob slightly counterclockwise  to "ON" until the burner ignites. If the burner does not ignite within 10 seconds with the match burning, turn the gas control knob to "OFF" and wait 5 minutes. Repeat Steps 5 and 6.
7. If the burner will not stay lit after several tries, turn the gas control knob to off and call your service technician or gas supplier.

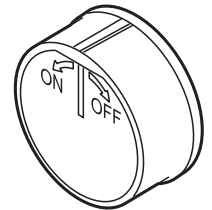



Figure 58 -
Control Knob

TO TURN OFF GAS TO HEATER

1. Turn gas control knob slightly clockwise  to **OFF** position. Do not force.

CHECKING BURNER FLAMES

Flame should be yellow and extend vertically (not curling toward fireplace screen).

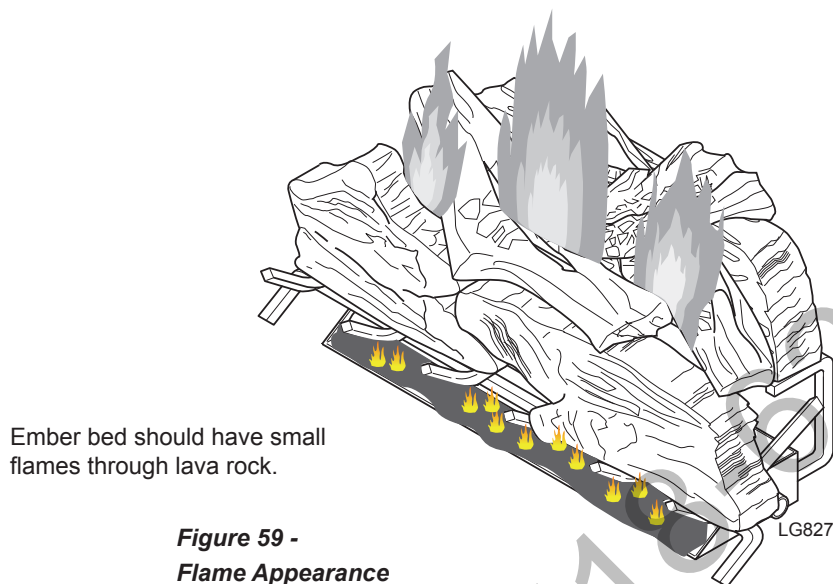

**Figure 59 -
Flame Appearance**

PILOT FLAME APPEARANCE

The pilot flame must always be present when appliance is operating. It should just touch the top of the thermocouple/thermopile tip.

During manufacturing, fabricating, and shipping, various components of this appliance are treated with certain oils, films, or bonding agents. These chemicals are not harmful, but may produce annoying smoke and smells as they burn off the first time the appliance is used. Operate the appliance 2 to 3 hours at the highest setting to burn off all the oils, films, etc. Never use this appliance with glass doors closed. This could cause severe sooting outside the fireplace. Always operate this appliance with the fireplace screens in place.

IMPORTANT: Fireplace Draft Test During Initial Installation

It is critical to verify that your chimney is drafting properly because the fireplace and gas logs function as a system.

Although MHSC. goes to great lengths to design vented gas log sets that minimize sooting, all vented log sets will soot over time. Sooting normally appears as areas of black powder-like substance on the logs. It is important to periodically clean and inspect the logs per the cleaning and servicing.

WARNING

Fireplace systems that do not draft properly can increase the amount of soot produced by normal operation of the log set and, in extreme cases, can cause soot to be deposited within the room. This effect can be a sign of a blocked chimney, a faulty vent system or the result of negative pressure within the home. The dealer should be able to diagnose if a problem exists and be able to provide a solution to improve the venting of the fireplace.

FIREPLACE DRAFT TEST METHOD

To determine if your fireplace is drafting properly, turn the log set on. After log set has been burning for about 10 minutes, place a match or smoke stick along the top and sides of the fireplace opening. If the flame or smoke is not pulled into the fireplace, then **the fireplace is not venting properly**. At this point, the damper stop should be adjusted so that the damper opening is increased. If the problem remains after the open area of the damper is increased, then the fireplace system should be professionally inspected to determine if your firebox/chimney is venting properly.

WARNING

Turn off gas logs and allow to cool before cleaning. Disconnect electrical power if applicable before cleaning or servicing.

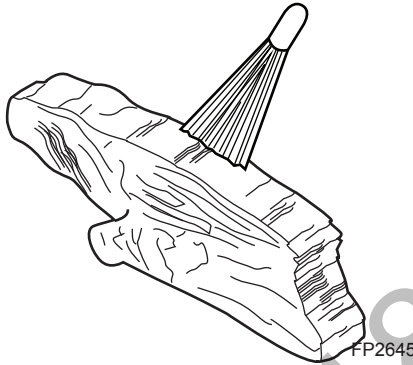

**Figure 60 -
Remove Soot with a Soft Bristle Brush**

The log set should be cleaned at least once a year for maximum performance.

Turn gas supply off. Allow unit to cool. Remove logs, handling carefully by holding gently at each end. Gloves are recommended when handling the log. Refer to manual for correct log placement. Brush each log gently with a soft bristle brush. This will remove soot that has built up on the log set.

DO NOT USE LIQUID SOOT REMOVER ON LOGS!

To refurbish the grate, remove grate and take it outside. Use a wire brush to remove any discoloration to the grate.

If lava rock has turned a rust color and become brittle, remove old lava rock from log set. Replace with new lava rock that can be purchased from your local dealer. Refer to log placement section for placement of lava rock.

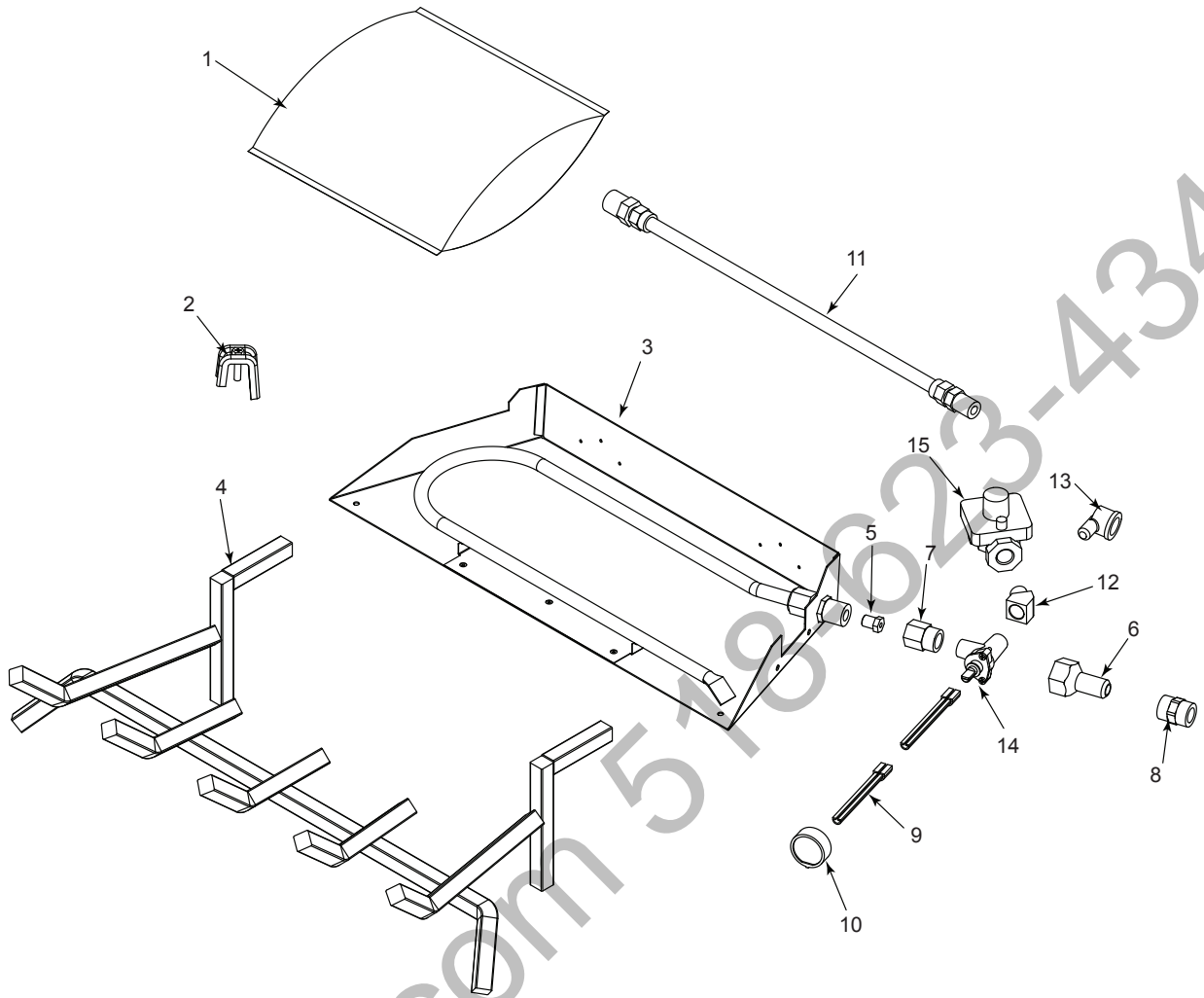

Ref.	Description	VWFOD
1.	Lava Rock	00F5040
2.	Damper Clamp	00F0545
3.	Burner SS VWFOD24	20300357
3a.	Burner SS VWFOD30	20300531
4.	Grate SS VWFOD24	20300514
4a.	Grate SS VWFOD30	20300356
5.	Natural Gas Injector - Natural gas only	27D7022
6.	Propane Injector - LP only	27D0406
7.	Ball Reducer 1/2" x 3/8" - Natural gas only	20300536
8.	Coupling - LP only	20300700
9.	Shaft Extender	27D0410
10.	Control Knob	27D0602
11.	SS Flex Line w/ 3/8" x 3/8" Flare Connector & 1/2" x 3/8" Flare Connector	20H0022
12.	3/8" x 3/8" Brass Street 45 deg - LP Only	27D0307
13.	1/2" FPT to 3/8" Flare 90 Connector	27D5134
14.	Manual Valve Control	27D0303
15.	LP Regulator - LP Only	24D0306

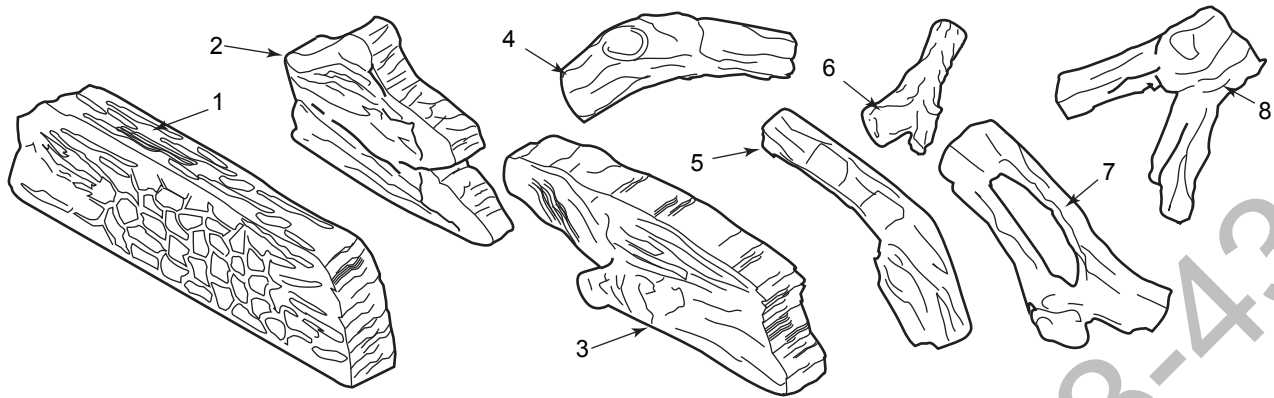

MASSIVE OAK LOGS

Ref.	Description	Qty.	VWFOD24	VWFOD30
1.	Back Log	1	27D7506	27D7510
2.	Left Front Log	1	27D7507	27D7511
3.	Right Front Log	1	27D7508	27D7512
4.	Left Side Middle Log	1	27D7503	27D7503
5.	Right Side Middle Log	1	27D7504	27D7504
6.	Right Top Log	1	27D8826	27D8826
7.	Left Top Log	1	--	27D7509
8.	Top Crossover Log	1	--	27D7513

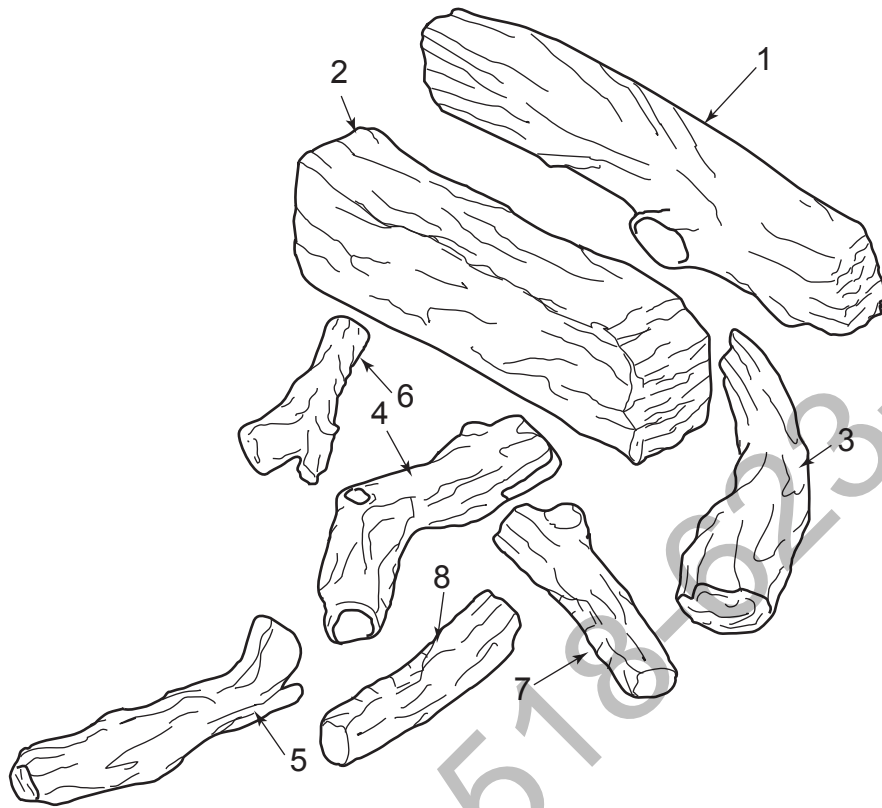

AMERICAN OAK LOGS

Ref.	Description	Qty.	VWFOD24	VWFOD30
1.	Front Log	1	27D8584	27D8592
2.	Back Log	1	27D8585	27D8593
3.	Right Middle Log	1	27D8588	--
4.	Left Middle Log	2	27D8580	27D8580
5.	Top Right Log	2	--	27D8594
6.	Top Left Log	1	27D8587	--
7.	Top Center Log	1	--	27D8578
8.	Top, Top Center Log	1	--	27D8600

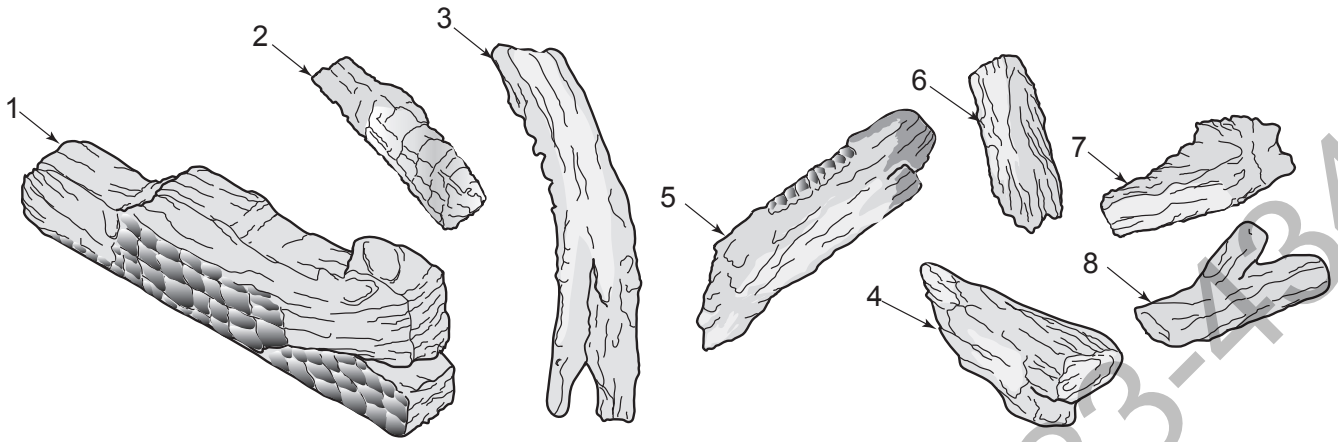

SPLIT RIVER OAK LOGS

Ref.	Description	Qty.	VWFOD24	VWFOD30
1.	Front Log	1	27D8807	27D8814
2.	Bottom Left Log	1	27D8808	27D8815
3.	Bottom Right Log	1	27D8809	27D8816
4.	Top Right Log	1	27D8810	27D8817
5.	Bottom Front Left Log	1	27D8811	27D8818
6.	Top Left Log	1	27D8812	27D8812
7.	Center Top Log	1	27D8813	27D8820
8.	Front Right Log	1	--	27D8821

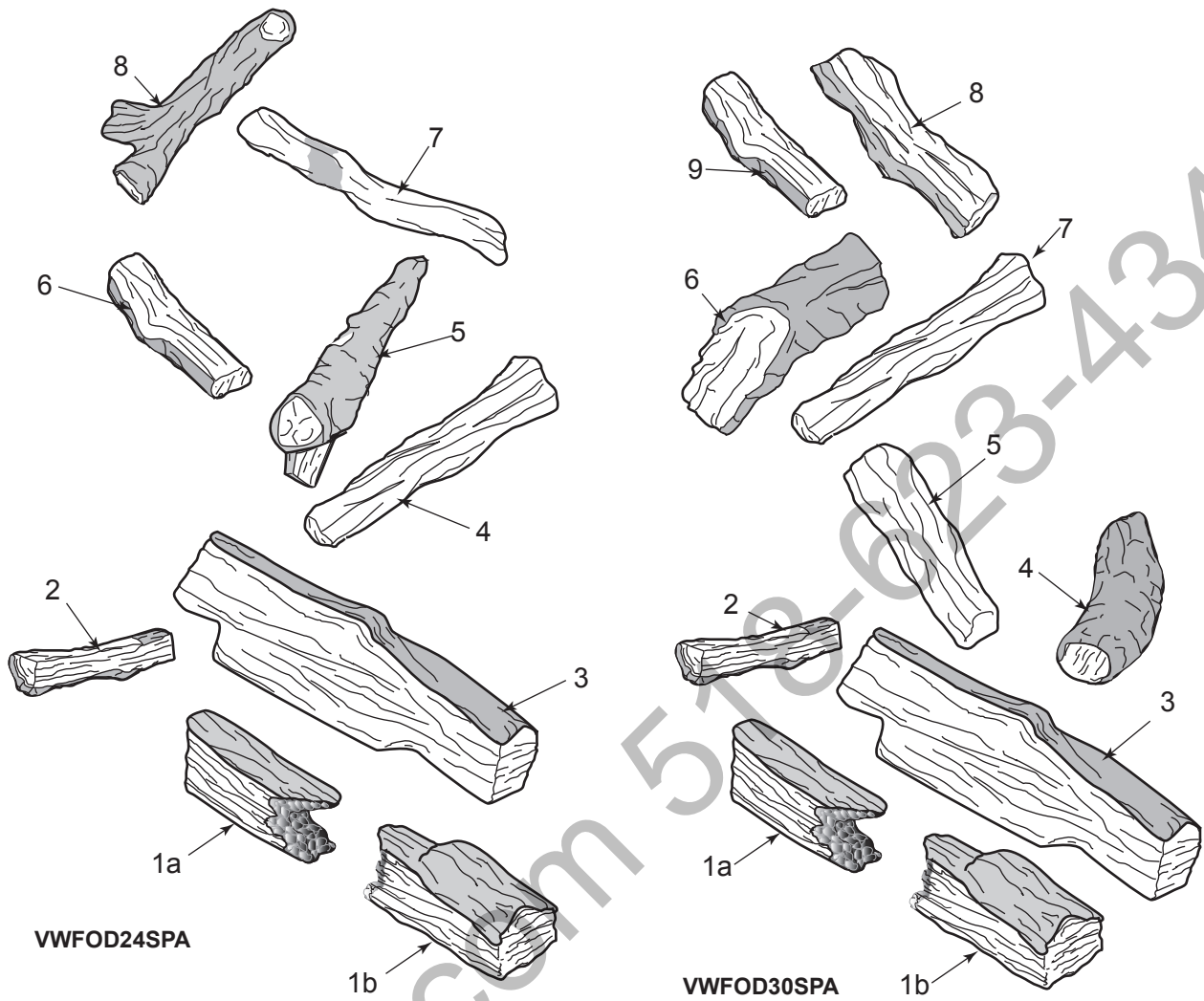

SPLIT PINE LOGS

Ref.	Description	Qty.	VWFOD24	VWFOD30
1a.	Front Left Log	1	27D8702	27D8704
1b.	Right Front Log	1	27D8703	27D8705
2.	Side Support Log	1	27D8551	27D8567
3.	Rear Log	1	27D8560	27D8568
4.	Right Log	1	27D8561	27D8569
5.	Right Middle Log	1	27D8562	27D8570
6.	Left Log	1	27D8555	27D8571
7.	Top Center Log	1	27D8556	27D8561
8.	Top Left Log	1	27D8565	27D8573
9.	Top, Top Left Log	1	--	27D8555

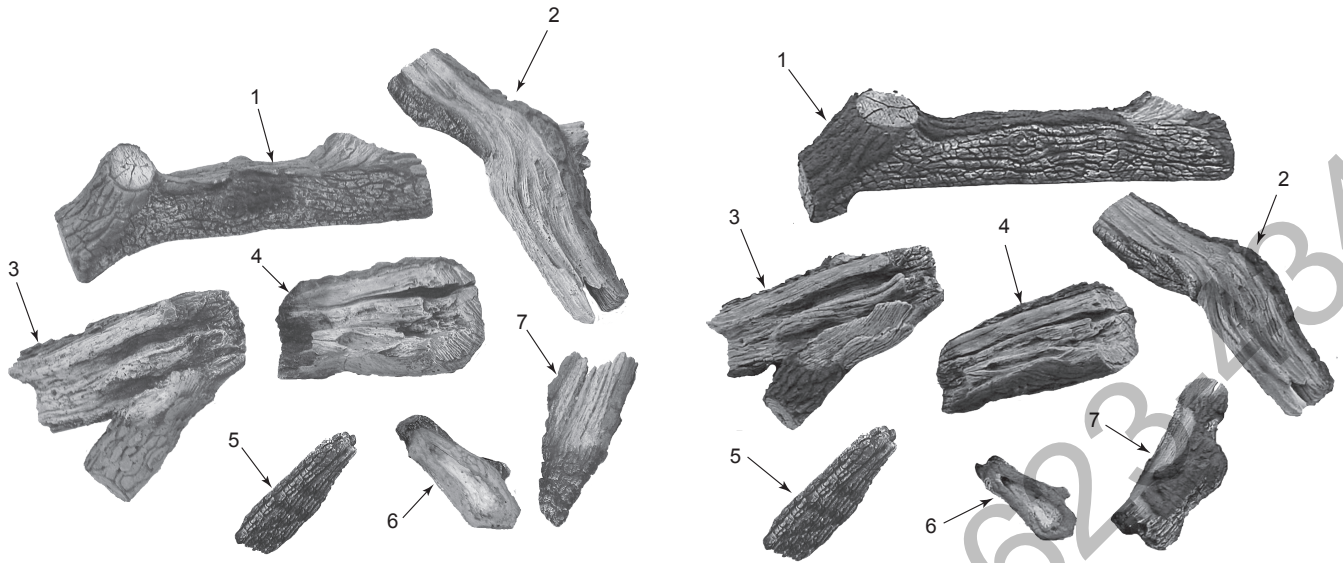

WEATHERED PINE LOGS

Ref.	Description	Qty.	VWFOD24	VWFOD30
1.	Rear Log	1	27D5146	27D5152
2.	Bottom Right Log	1	27D5147	27D5153
3.	Bottom Left Log	1	27D5148	27D5154
4.	Top Right Log	1	27D5149	27D5155
5.	Top Left Log	1	27D5150	27D5156
6.	Mid Front Log	1	27D5145	27D5145
7.	Top Center Log	1	27D5151	27D5157

Requirements for the Commonwealth of Massachusetts

This product must be installed by a licensed plumber or gas fitter when installed within the Commonwealth of Massachusetts.

Note Regarding Vented Products

Flex line installation must not exceed 36 inches and must have a T shutoff valve.

Any residence with a direct vent product must have a CO detector installed in the residence.

Installation of the fireplace or vented gas log in the State of Massachusetts requires the damper to be permanently removed or welded in the fully open position.

In addition, neither a naturally vented gas log nor a vent-free product may be installed in a bedroom or bathroom in the State of Massachusetts.

All gas fitting and installation of this heater shall only be done by a licensed gas fitter or licensed plumber.

For all side wall horizontally vented gas fueled equipment installed in every dwelling, building or structure used in whole or in part for residential purposes, including those owned or operated by the Commonwealth and where the side wall exhaust vent termination is less than seven (7) feet above finished grade in the area of the venting, including but not limited to decks and porches, the following requirements shall be satisfied:

Installation of Carbon Monoxide Detectors

At the time of installation of the side wall horizontal vented gas fueled equipment, the installing plumber or gas fitter shall observe that a hard wired carbon monoxide detector with an alarm is installed on each additional level of the dwelling, building or structure served by the side wall horizontal vented gas fueled equipment. It shall be the responsibility of the property owner to secure the services of qualified licensed professionals for the installation of hard wired carbon monoxide detectors.

In the event that the side wall horizontally vented gas fueled equipment is installed in a crawl space or an attic, the hard wired carbon monoxide detector with alarm and battery back-up may be installed on the next adjacent floor level.

In the event that the requirements of this subdivision can not be met at the time of completion of installation, the owner shall have a period of thirty (30) days to comply with the above requirements; provided, however, that during said thirty (30) day period, a battery operated carbon monoxide detector with an alarm shall be installed.

Approved Carbon Monoxide Detectors

Each carbon monoxide detector as required in accordance with the above provisions shall comply with NFPA 720 and ANSI/UL 2034 listed and IAS certified.

Signage

A metal or plastic identification plate shall be permanently mounted to the exterior of the building at a minimum height

of eight (8) feet above grade directly in line with the exhaust vent terminal for the horizontally vented gas fueled heating appliance or equipment. The sign shall read, in print size no less than one-half (1/2) inch in size, **“GAS VENT DIRECTLY BELOW, KEEP CLEAR OF ALL OBSTRUCTIONS”**.

Inspection

The state or local gas inspector of the side wall horizontally vented gas fueled equipment shall not approve the installation unless, upon inspection, the inspector observes carbon monoxide detectors and signage installed in accordance with the provisions of 248 CMR 5.08(2)(a)1 through 4.

Exemptions

The following equipment is exempt from 248 CMR 5.08(2)(a)1 through 4:

- The equipment listed in Chapter 10 entitled “Equipment Not Required To Be Vented” in the most current edition of NFPA 54 as adopted by the Board; and
- Product Approved side wall horizontally vented gas fueled equipment installed in a room or structure separate from the dwelling, building or structure used in whole or in part for residential purposes.

MANUFACTURER REQUIREMENTS

Gas Equipment Venting System Provided

When the manufacturer of Product Approved side wall horizontally vented gas equipment provides a venting system design or venting system components with the equipment, the instructions provided by the manufacturer for installation of the equipment and the venting system shall include:

- Detailed instructions for the installation of the venting system design or the venting system components; and
- A complete parts list for the venting system design or venting system.

Gas Equipment Venting System NOT Provided

When the manufacturer of a Product Approved side wall horizontally vented gas fueled equipment does not provide the parts for venting the flue gases, but identifies “special venting systems”, the following requirements shall be satisfied by the manufacturer:

- The referenced “special venting system” instructions shall be included with the appliance or equipment installation instructions; and
- The “special venting systems” shall be Product Approved by the Board, and the instructions for that system shall include a parts list and detailed installation instructions.

A copy of all installation instructions for all Product Approved side wall horizontally vented gas fueled equipment, all venting instructions, all parts lists for venting instructions, and/or all venting design instructions shall remain with the appliance or equipment at the completion of the installation.

LIMITED LIFETIME WARRANTY POLICY

LIFETIME WARRANTY

The following components are warranted for life to the original owner, subject to proof of purchase: Firebox, Combustion Chamber, Heat Exchanger, Grate, Stainless Steel Burners and Refractory Logs.

FIVE YEAR WARRANTY

The following components are warranted five (5) years to the original owner, subject of proof of purchase: Ceramic Fiber Logs, Catalytic Filter and Aluminized Burners.

BASIC WARRANTY

MHSC warrants the components and materials in your gas appliance to be free from manufacturing and material defects for a period of two years from date of installation. After installation, if any of the components manufactured by MHSC in the appliance are found to be defective in materials or workmanship, MHSC will, at its option, replace or repair the defective components at no charge to the original owner. MHSC will also pay for reasonable labor costs incurred in replacing or repairing such components for a period of two years from date of installation. Any products presented for warranty repair must be accompanied by a dated proof of purchase.

This Limited Lifetime Warranty will be void if the appliance is not installed by a qualified installer in accordance with the installation instructions. The Limited Lifetime Warranty will also be void if the appliance is not operated and maintained according to the operating instructions supplied with the appliance, and does not extend to (1) firebox/burner assembly damage by accident, neglect, misuse, abuse, alterations, negligence of others, including the installation thereof by unqualified installers, (2) the costs of removal, reinstallation or transportation of defective parts on the appliance, or (3) incidental or consequential damage. All service work must be performed by an authorized service representative.

This warranty is expressly in lieu of other warranties, express or implied, including the warranty of merchantability of fitness for purpose and of all other obligations or liabilities. MHSC does not assume for it any other obligations or liabilities in connection with sale or use of the appliance. It states that do not allow limitations on how long an implied warranty lasts, or do not allow exclusion of indirect damage, those limitations of exclusions may not apply to you. You may also have additional rights not covered in the Limited Lifetime Warranty.

MHSC reserves the right to investigate any and all the claims against the Limited Lifetime Warranty and decide upon method of settlement.

IF WARRANTY SERVICE IS NEEDED...

1. Contact your supplier. Make sure you have your warranty, your sales receipt and the model/serial number of your MHSC product.
2. DO NOT ATTEMPT TO DO ANY SERVICE WORK YOURSELF.

MHSC

149 Cleveland Drive • Paris, Kentucky 40361
www.mhsc.com