

PRODUCT CATALOGUE

HI-TEMP
MODEL HT
CHIMNEY

**Stainless Steel
Insulated
Chimney**

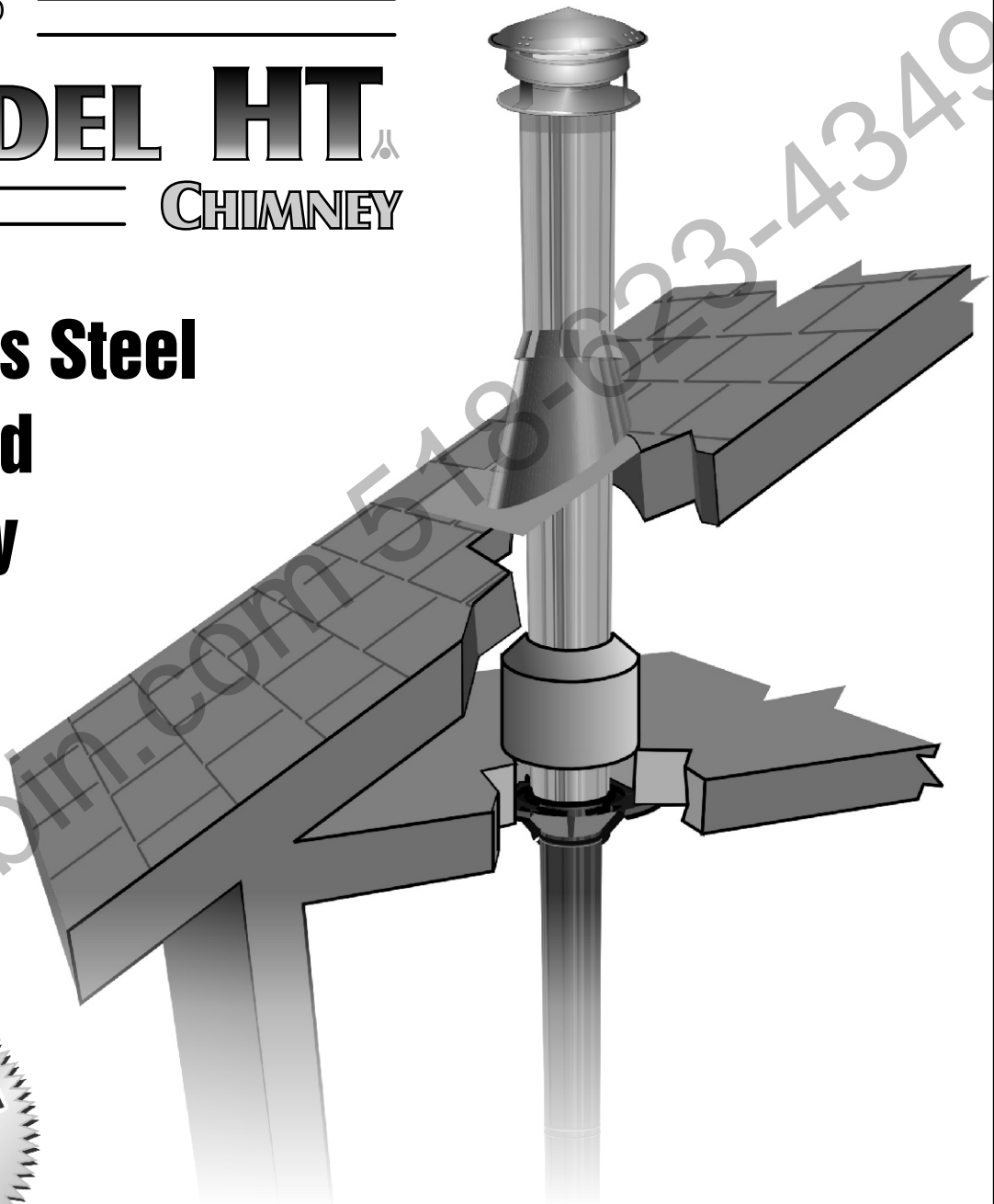

4" Diameter

Model HT Stainless Steel Insulated Chimney

- Model HT is an All Fuel Chimney approved for Gas, Oil and Wood* burning applications.
- Tested and Listed to ULC S-604 and UL103HT.
- All 300 Series Stainless Steel Construction.
- 1" "Solid Pack" Insulation.
- Ideal for Oil Stove installations.
- Model HT requires only 2" clearance to combustibles.
- Smart Choice Lifetime Warranty.

*Approved for Wood burning applications only in the United States.

Fixed Lengths

For installed length, subtract 1" per joint.

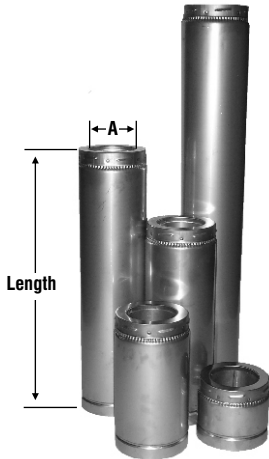

- Available in Lengths of 6", 12", 18", 24" and 36".

DIA.	LENGTH	DIMENSIONS		PRODUCT CODE
		A		
4"	6"	4"		204006U
4"	12"	4"		204012U
4"	18"	4"		204018U
4"	24"	4"		204024U
4"	36"	4"		204036U

Elbows

For installed length, subtract 1" per joint.

45 DEGREE ELBOWS

30 DEGREE ELBOWS

15 DEGREE ELBOWS



- Used to offset pipe around construction obstacles.
- 45 Degree Elbows are not Listed components.
- 2 Elbows per carton.

DESCRIPTION	DIAMETER	DIMENSIONS			Degree	PRODUCT CODE
		A	B	C		
45° Elbow	4"	4"	6"	N/A	45	204216
30° Elbow	4"	4"	6"	N/A	30	204211
15° Elbow	4"	4"	6"	N/A	15	204206

INSULATED TEE

GALVANIZED CLEAN OUT

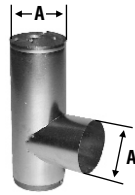
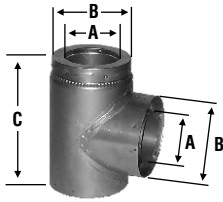

- Used to transition system from horizontal to vertical orientation.
- Provides easy access for inspection and maintenance.
- Includes Tee Cap.

- Galvanized Clean Out is always situated in the room with the heating appliance.
- Cap can be removed for inspection.
- Includes Tee Cap

DESCRIPTION	DIAMETER	DIMENSIONS			PRODUCT CODE
		A	B	C	
Insulated Tee	4"	4"	6"	10"	204100
Galvanized Clean Out	4"	4"	N/A	N/A	HT4GCT

Supports

BLACK CEILING SUP.

LARGE CEILING SUP.

ROOF SUPPORT

WALL SUPPORT

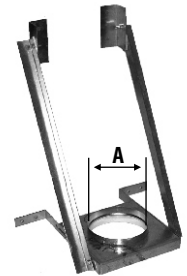
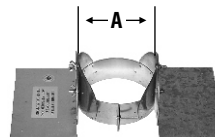
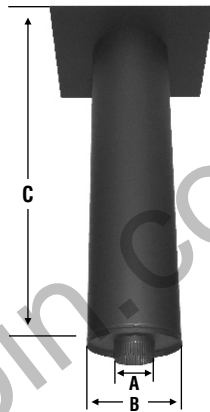
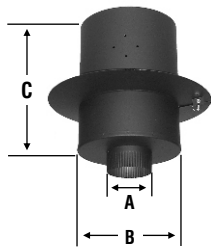

- Used to support chimney from the ceiling joist.
- Supports up to 50' of chimney.
- Centres chimney between floors.
- Round design with decorative Black hi-temp paint finish.
- 9" x 9" framing dimensions

- Used to support pipe for cathedral ceiling installations.
- Centres chimney between floors.
- Installed above the joist, with a Firestop Spacer installed below the joist.

- Used for lateral support only.

- Used to stabilize the chimney against an outside wall.
- Supports up to 50' of chimney.

DESCRIPTION	DIAMETER	DIMENSIONS			PRODUCT CODE
		A	B	C	
Black Ceiling Support	4"	4"	9"	12"	HT4BCS
Large Ceiling Support	4"	4"	9"	36"	HT4LCS
Roof Support	4"	6"	N/A	N/A	HT4RS
Wall Support	4"	5-1/2"	N/A	N/A	HT4WS

Supports (continued)

INTERIOR OFFSET SUP.



- Will support up to 25 ft.
- Must be installed above the second elbow.

WALL BAND

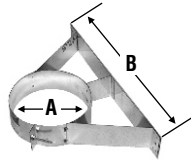

- Used to stabilize the chimney against an outside wall.
- Must be installed just above the Tee and every 6 ft. thereafter.

ROOF BRACE BAND/POLES

PHOTO NOT AVAILABLE

- Used to stabilize the chimney above the roof level.
- If chimney exceeds more than 5 ft. above the roof the Roof Brace Band and poles must be used.

STARTER BOX

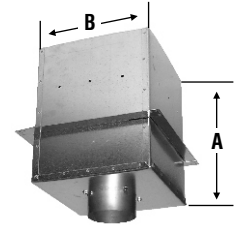

- Can be used in place of Black Ceiling Support.
- Used in commercial applications.
- Galvanized

DESCRIPTION	DIAMETER	DIMENSIONS		PRODUCT CODE
		A	B	
Interior Offset Support	4"	6"	N/A	HT4IOS
Wall Band	4"	6"	14"	HT4WB
Roof Brace Band	4"	6"	N/A	HT4RBB
Roof Brace Poles (2)	4"	N/A	N/A	HT4RBP
Starter Box	4"	12"	10"	HT4SB

Flashings & Storm Collar

TALL CONE FLASHING

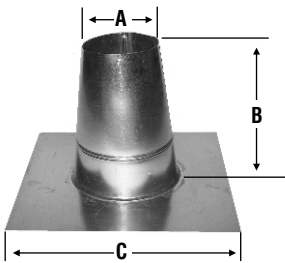

- Used to water proof installations through a flat roof.
- ULC Listed (only)

ADJ. ROOF FLASHING

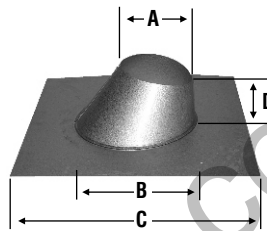

- Used to water proof installations that penetrate the roof line.
- Adjustable for 0/12 - 6/12 pitches.
- ULC Listed (only)

STEEP ROOF FLASHING

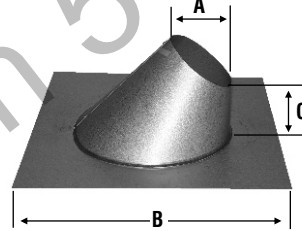

- Used to water proof installations that penetrate the roof line.
- Adjustable for 6/12 - 12/12 pitches.
- ULC Listed (only)

STORM COLLAR

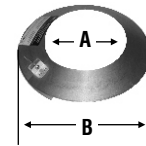

- Used to provide a weather proof seal to chimney above roof flashing
- Seal inner edge with hi-temp silicone sealant.

DESCRIPTION	DIAMETER	DIMENSIONS				Roof Pitch	PRODUCT CODE
		A	B	C	D		
Tall Cone Flashing	4"	6-1/8"	10-1/2"	18"	N/A	Flat Roof	HT4TCF
Adj. Roof Flashing	4"	6-1/4"	11"	20"	4"	0/12 - 6/12	HT4ARF
Steep Roof Flashing	4"	6-1/4"	22"	4-3/4"	N/A	6/12 - 12/12	HT4SRF
Storm Collar	4"	6"	10"	N/A	N/A	N/A	HT4SC

Parts & Accessories

RAIN CAP

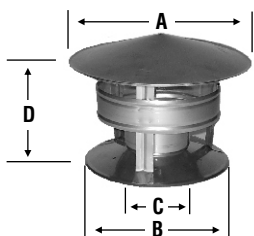

- Designed to prevent rain & snow from entering the chimney.

DIA.	DIMENSIONS				PRODUCT CODE
	A	B	C	D	
4"	11"	9"	4"	7-1/2"	HT4RC
4"	N/A	N/A	N/A	N/A	CH4SS

Spark Screen (not shown)

Parts & Accessories

FIRESTOP RADIATION SHIELD

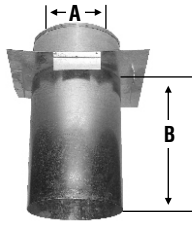

- Required where the chimney penetrates a floor or ceiling.

DIA.	DIMENSIONS		PRODUCT CODE
	A	B	
4"	6-1/8"	12"	HT4FRS

WALL RADIATION SHIELD

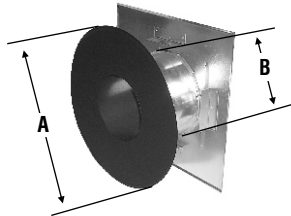

- Used to protect combustible materials where the chimney passes through a wall.
- Decorative black trim plate.

DIA.	DIMENSIONS		PRODUCT CODE
	A	B	
4"	15"	8"	HT4WRS

FIRESTOP SPACER

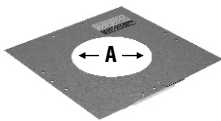

- Used to protect combustible materials where the chimney passes through a ceiling or wall.

DIA.	DIMENSIONS		PRODUCT CODE
	A		
4"	6-1/8"		HT4FS

ATTIC INSULATION SHIELD

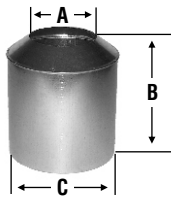

- Used wherever the chimney enters an open attic space.
- Acts as an insulated shield to keep blown or blanket insulation from filling in any framed opening or contacting the chimney.

DIA.	DIMENSIONS			PRODUCT CODE
	A	B	C	
4"	6-1/8"	12"	10"	HT4AIS

ANCHOR PLATE

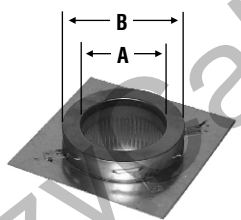

- Used to adapt chimney to a Listed Factory-Built Fireplace certified for use with Model HT.
- Retains chimney with a twist-lock connection.
- Follow the installation instructions that accompany the Fireplace.
- Not a Listed component.

DIA.	DIMENSIONS		PRODUCT CODE
	A	B	
4"	4"	6"	HT4AP

PIPE ADAPTER



- Used as a vertical or horizontal connection between chimney lengths and connector pipe.

DIA.	DIMENSIONS		PRODUCT CODE
	A	B	
4"	4"	6"	HT4PA

The Smart Choice Limited Lifetime Warranty

LIMITED LIFETIME WARRANTY

LIMITED LIFETIME WARRANTY:

Selkirk Canada Corporation, (“we”, “us”, “our”) warrants Chimney & Venting products * to be free from defects in material and workmanship for as long as the original consumer owns the system. For products installed after January 1, 2000, for a period of Ten (10) years from original installation, we will provide replacement product with a similar or like quality of available product, **free of charge** excluding any installation costs. From the Eleventh (11) through Fifteenth (15) years we will provide replacement product to the original consumer at a cost of 75% off the published Retail Price in effect on the date the claim is received excluding any installation costs. At expiration of the Fifteen (15) year term, we will provide replacement product to the original consumer at a cost of 50% off the published Retail Price in effect on the date the claim is received excluding any installation costs.

* additional coverage applies to Model CF Chimney

LIMITATIONS:

- - Products must be installed for their intended purpose.
- - Products must be connected to residential appliance listed with an accredited testing laboratory.

WARNING: FAILURE TO INSTALL PRODUCTS ACCORDING TO THE MANUFACTURER’S INSTRUCTIONS WILL VOID ALL APPLICABLE WARRANTIES AND MAY RESULT IN FIRE, CARBON MONOXIDE POISONING OR DEATH. SEE OUR PRODUCT INSTALLATION INSTRUCTIONS FOR COMPLETE INSTRUCTIONS.

WARRANTY COVERAGE:

All lengths, tees and elbows, and components are applicable to warranty coverage.

THIS LIMITED WARRANTY DOES NOT COVER:

- (a) any non-stainless base tee unit mounted or connected to an Insulated Chimney system;
- (b) **costs (labor or otherwise **) associated with either removing a previously installed product, installing a replacement product, transportation or return of a product, or transportation of replacement product;**
- (c) damage to the finish of products caused by the use of improper solvents/chemicals or improper cleaning methods;
- (d) damage resulting from failure to reasonably clean, care for or maintain products in accordance with our installation instructions/recommendations;
- (e) damage (to products, appliances or structure) based on or resulting from improper installation or repair, misuse or abuse (including, but not limited to, excessive or improper operating condition), or alteration or adjustment other than in conformity with our installation instructions and specifications, whether performed by a contractor, service company, technician, or yourself;
- (f) any products that have been moved from their original installation site.
- (g) damage caused by burning driftwood, garbage, or any other prohibitive material has been burned in the appliance served by the chimney
- (h) damage that results from accidents such as fire, flood, high winds, “acts of God”, or any other contingency beyond our control.

**** Due to the wide variance in installation practices and other conditions beyond our control, we do not guarantee or in any way warrant the installation of Chimney and Venting products.**

CLAIM PROCEDURE:

If you believe that a product is defective, notify us in writing at the following location:

SELKIRK CANADA CORPORATION

P.O. Box 526, Depot 1,
Hamilton, Ontario, CANADA, L8L 7X6
ATTN: WARRANTY CLAIMS DEPARTMENT
905-662-6600, 800-263-9308, Fax: (905) 662-5352
www.selkirkcanada.com

SELKIRK LLC

ATTN: WARRANTY CLAIMS
P. O. Box 831950, Richardson, Texas, USA 75083-1950
1-800-992-VENT (8368)
Toll Free Fax: 1-877-393-4145
www.selkirkinc.com

Notification should include a description of the product, model and serial number (if applicable) and a description of the product defect. Upon receipt of a written claim under this limited warranty and evidence of the date of purchase or installation, at our option and in our sole discretion, we will provide replacement product with similar or like quality of available product excluding any installation costs. We reserve the right to inspect or investigate any warranty claims prior to determining whether to provide replacement product. If, as determined by us that repair or replacement of the product is not commercially practicable or cannot be completed in a timely manner, we may refund the prorated purchase price paid for the product upon verification by providing a copy of your invoice or receipt of bill of sale.

*Selkirk products covered under this warranty:

models: AFCL, ALT, BV, DSP, DT, DWC, DWS, EV, FC (JSC), L, PL, QC, RV, SC (JM), SFCL, SL, SPR, SSII, SS PLUS, ST, UT, VP, WV

SELKIRK CANADA CORPORATION

375 Green Road, Stoney Creek, ON L8E 4A5
TEL: 1-800-263-9308 • FAX: 1-866-835-9624

www.selkirkcanada.com

www.selkirkinc.com
email: info@selkirkcanada.com

SELKIRK LLC

P.O. Box 831950, Richardson, TX 75083-1950
TEL: 1-800-992-8368 • FAX: 1-877-393-4145